

EPSON®

Multimedia Projector

EB-810E

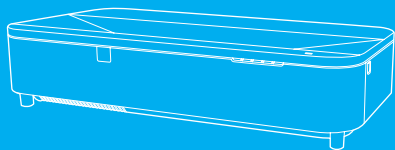

EN	Quick Start Guide	LV	Ātrās darba uzsākšanas pamācība
DE	Kurzanleitung	LT	Trumpas pradžios vadovas
FR	Guide de démarrage rapide	EL	Οδηγός γρήγορης εκκίνησης
IT	Guida di avvio rapido	TR	Hızlı Başlangıç Kılavuzu
ES	Guía de inicio rápido	SL	Priročnik za hitri zagon
PT	Guia de Referência Rápida	HR	Kratke upute
NL	Introductiehandleiding	MK	Прирачник брз почеток
DA	Introduktion	SR	Uputstvo za brz početak
FI	Pika-aloitusopas	CA	Guia d'inici ràpid
NO	Hurtigveiledning	RU	Руководство по быстрой установке
SV	Snabbstartsguide	UK	Коротка інструкція "Початок роботи"
CS	Úvodní příručka	KK	Қысқа іске қосу нұсқаулығы
HU	Bevezetés	KO	빠른 시작 가이드
PL	Przewodnik szybkiego startu	ID	Panduan Ringkas
SK	Stručná príručka	AR	دليل البداية السريعة
BG	Ръководство за бърз старт	FA	راهنمای سریع برای شروع بکار
RO	Ghid de pornire rapidă	ZHS	設定手册
ET	Lühijuhend	ZHT	設定說明書

Product Box Contents

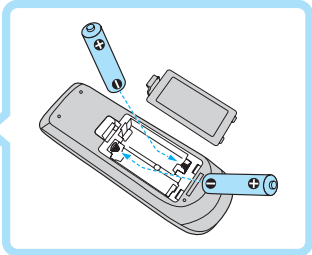
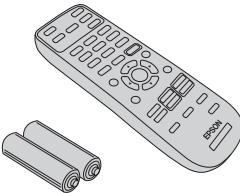
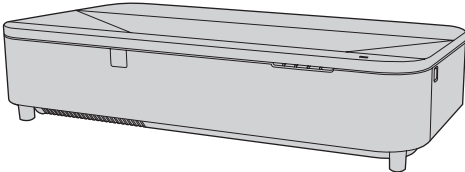

1

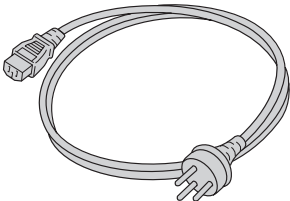

Turning On the Projector

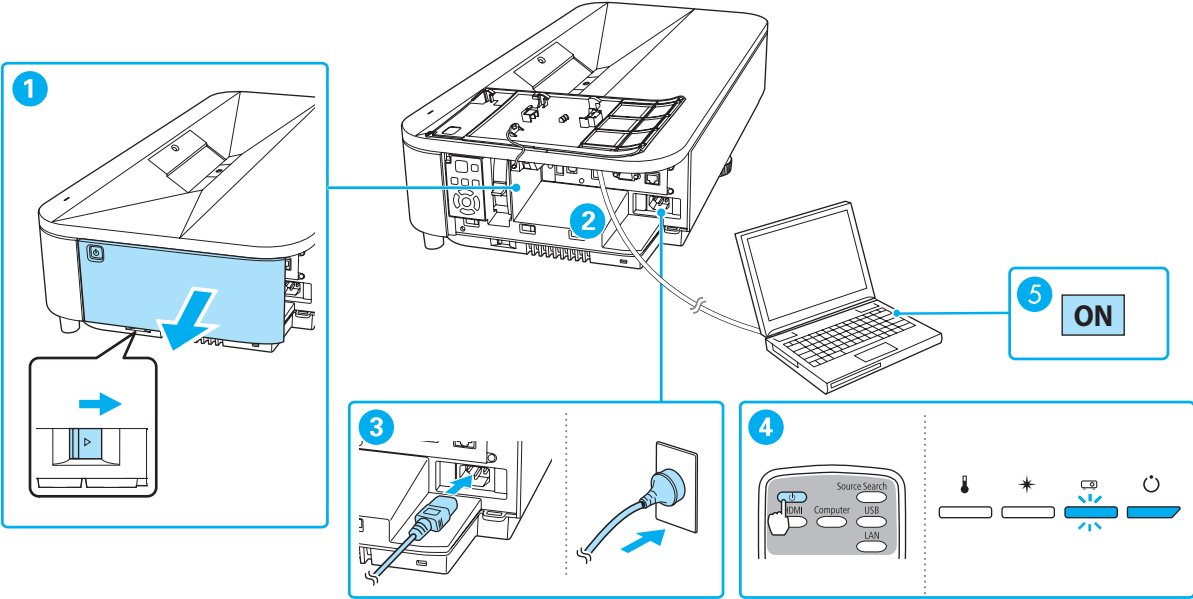

Initial Setting Wizard

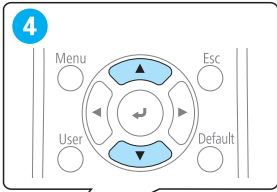
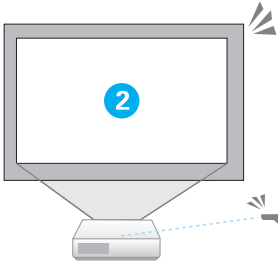
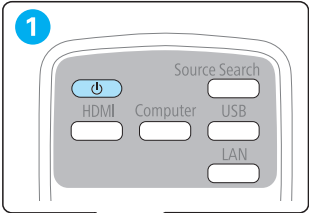

Home Screen

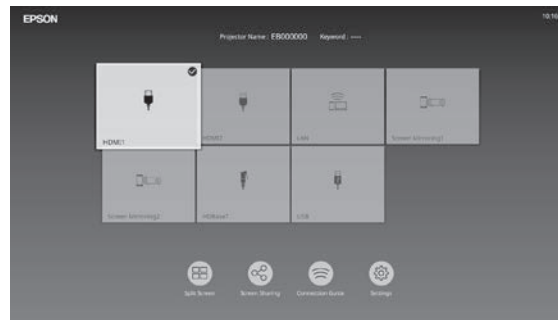
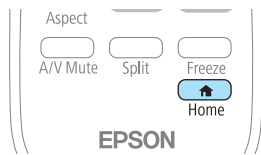

Adjusting the Image

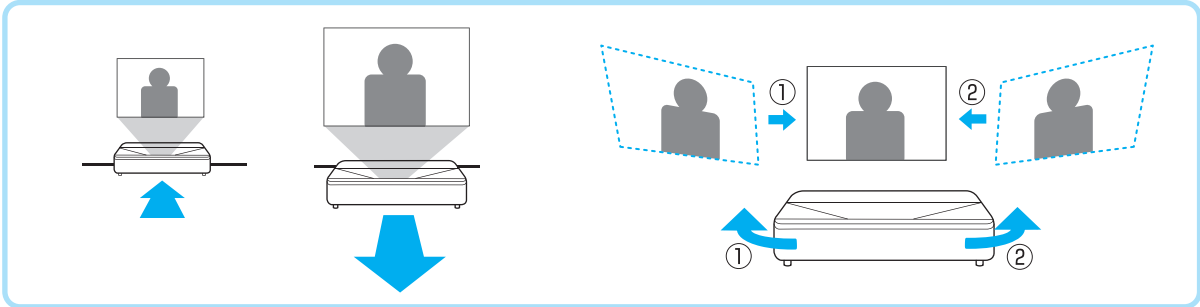

5

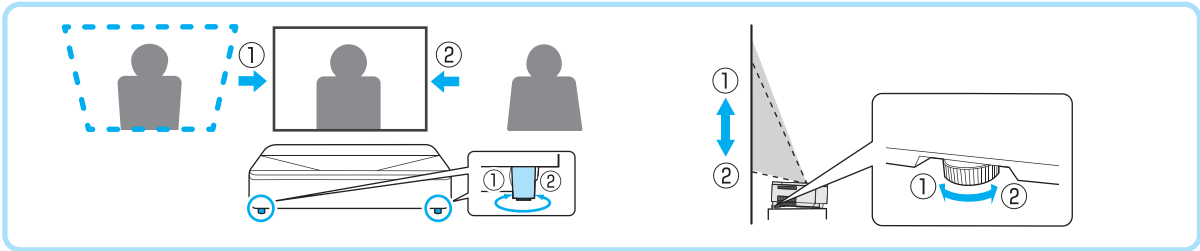

Changing the Projection Mode

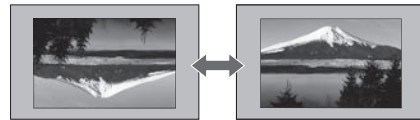
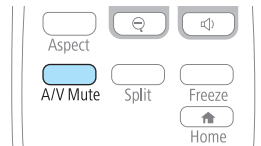

Adjusting the focus

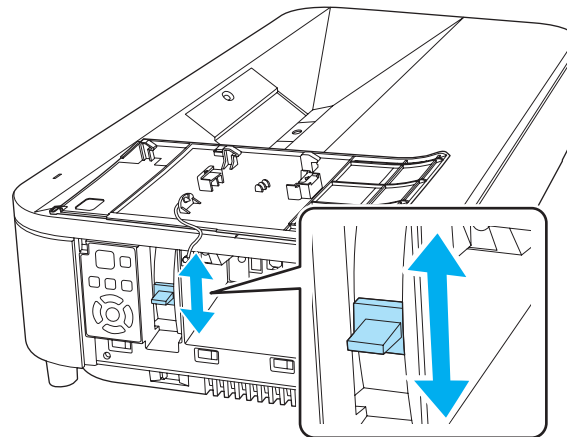
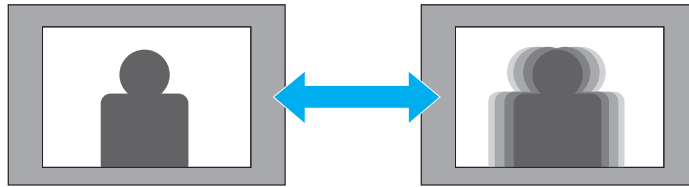

Correcting the Image Shape

7

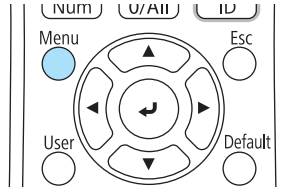
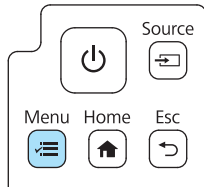

Connect to Setting Assistant

Frequently Used Items	Installation	
Image	Fixed Installation	Off
	Test Pattern	
	Setting Plate Installation Gui...	
Display	Projection	Front
	Geometry Correction	Point Correction
Operation	Geometry Correction Wizard	
Management	Connect to Setting Assistant	
Network	Digital Zoom	▼
Multi-Projection	Remote Receiver	Off
Memory	Screen Type	16:9 ▼
ECO	High Altitude Mode	Off
Initial/All Settings	Source	HDMI1
	Blanking	



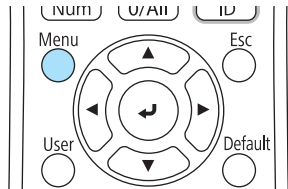
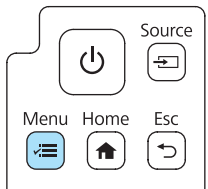

Geometry Correction

Frequently Used Items	Installation	
Image	Fixed Installation	Off
	Test Pattern	
	Setting Plate Installation Gui...	
	Projection	Front
	Geometry Correction	Point Correction
Operation	Geometry Correction Wizard	
Management	Connect to Setting Assistant	
Network	Digital Zoom	▼
Multi-Projection	Remote Receiver	Off
Memory	Screen Type	16:9 ▼
ECO	High Altitude Mode	Off
Initial/All Settings	Source	HDMI1
	Blanking	



Quick Corner

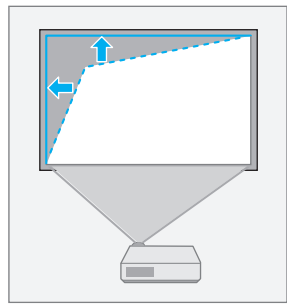

Arc Correction

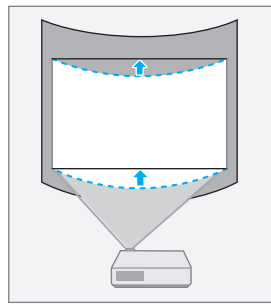

Point Correction

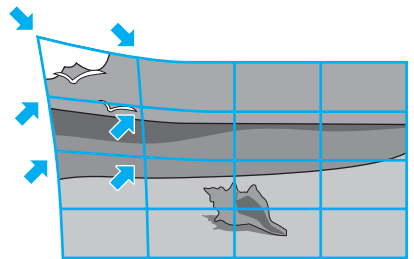

Connecting a Device

9

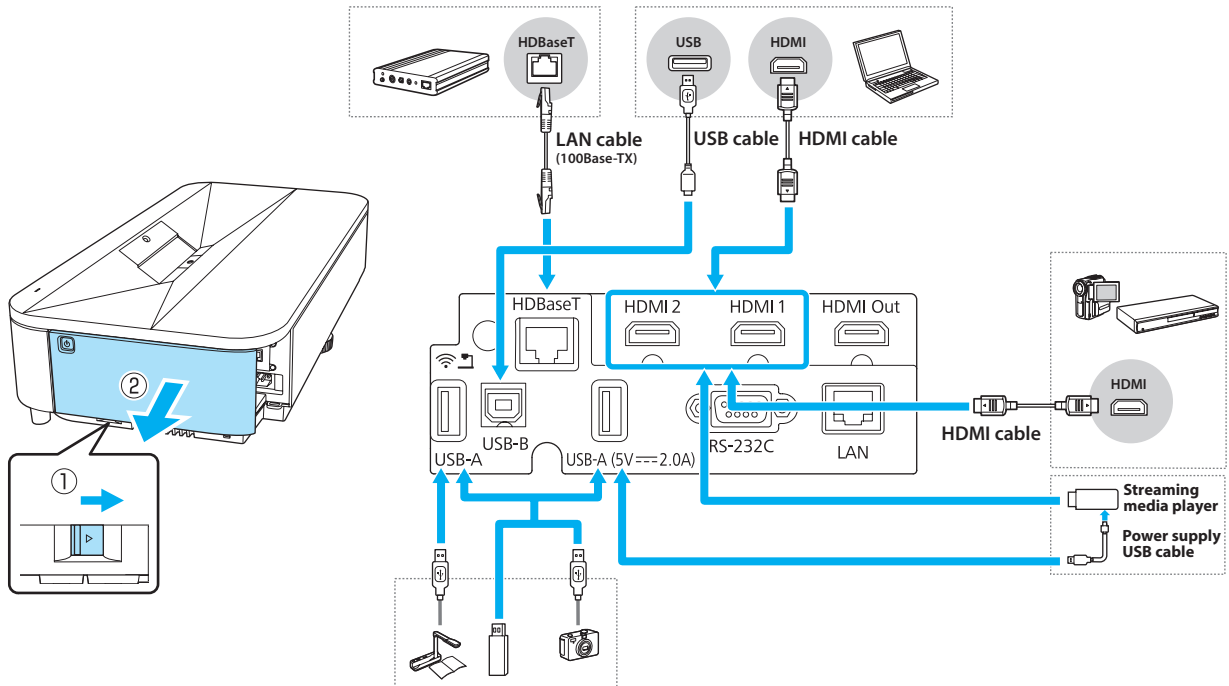

For More Information

epson.sn



http://epson.sn



EN	See the "User's Guide" on the Epson Web site for detailed instructions and specifications.	SK	Podrobné pokyny a špecifikácie nájdete v „Používateľská príručka“ na webovej stránke spoločnosti Epson.
DE	Beachten Sie die Bedienungsanleitung auf der Epson-Website für detaillierte Anweisungen und technische Daten.	BG	Вижте Потребителско ръководство на уеб сайта на Epson за подробни инструкции и технически характеристики.
FR	Consultez le "Guide de l'utilisateur" sur le site Web d'Epson afin d'obtenir les instructions et les caractéristiques détaillées.	RO	Consultați „Ghidul utilizatorului” de pe site-ul web Epson pentru instrucțiuni și specificații detaliate.
IT	Per istruzioni e specifiche dettagliate, vedere la "Manuale dell'utente" sul sito Web Epson.	EL	Ανατρέξτε στον «Εγχειρίδιο χρήσης» στην ιστοσελίδα της Epson για λεπτομερείς οδηγίες και προδιαγραφές.
ES	Consulte la "Manual de usuario" en el sitio web de Epson para obtener instrucciones y especificaciones detalladas.	TR	Ayrıntılı talimatlar ve teknik özellikler için Epson Web sitesindeki "Kullanım Kılavuzu"na bakın.
PT	Consulte instruções e especificações detalhadas no "Manual do utilizador" no website da Epson.	SL	Za podrobna navodila in tehnične podatke si oglejte »Priročnik za uporabnika« na spletnem mestu družbe Epson.
NL	Raadpleeg de "Gebruikershandleiding" op de website van Epson voor gedetailleerde instructies en specificaties.	HR	Pogledajte "Priručnik za uporabu" na Epsonovoj web-stranici s detaljnim uputama i tehničkim podacima.
DA	Du kan finde yderligere vejledninger og specifikationer i afsnittet "Brugerhåndbog" på Epsons hjemmeside.	CA	A la "Guia de l'usuari" del lloc web d'Epson trobareu instruccions detallades i les especificacions.
FI	Katso Epson-verkkosivuston "Käyttäjän opas"-kohdasta yksityiskohtaiset tiedot ja tekniset tiedot.	RU	Подробные инструкции и технические характеристики см. в «Руководство по эксплуатации» на веб-сайте Epson.
NO	Se «Brukerhåndbok» på Epsons nettsted for detaljerte instruksjoner og spesifikasjoner.	UK	Детальну інструкцію та технічні характеристики див. у «Посібник користувача» на веб-сайті Epson.
SV	Se "Bruksanvisning" på Epsons webbplats för utförliga instruktioner och specifikationer.	KK	Толық нұсқаулар мен сипаттамаларды Epson веб-сайтындағы "Пайдаланушы нұсқаулығы" құжатынан қараңыз.
CS	Podrobné pokyny a špecifikace nájdete v dokumentu „Užívateľská príručka“ na webu spoločnosti Epson.	AR	راجع «دليل المستخدم» في موقع Epson على الويب للاطلاع على التعليمات التفصيلية والمواصفات.
HU	A részletes utasításokért és specifikációkért lásd a „Használati útmutató” dokumentumot az Epson webhelyén.	ZHS	请参见 Epson 网站中的“使用说明书”了解详细说明和规格。
PL	Sprawdź "Przewodnik użytkownika" na stronie internetowej Epson w celu uzyskania szczegółowych instrukcji i specyfikacji.	ZHT	關於詳細的說明與規格，請參考 Epson 網站上的「使用說明書」。
		KO	자세한 지침과 사양은 Epson 웹 사이트의 "사용자 가이드" 를 참조하십시오 .
		ID	Lihat Panduan Pengguna di situs web Epson untuk rincian instruksi dan spesifikasi.

