

Home Projector EH-LS650W EH-LS650B

EPSON® | androidtv



Quick Start Guide
Kurzanleitung
Guide de démarrage rapide
Guida di avvio rapido
Guía de inicio rápido
Guia de Referência Rápida
Introductiehandleiding
Introduktion
Pika-aloitusopas
Hurtigveiledning
Snabbstartsguide
Úvodní příručka
Bevezetés
Przewodnik szybkiego startu
Stručná příručka
Ghid de pornire rapidă
Οδηγός γρήγορης εκκίνησης
Hızlı Başlangıç Kılavuzu
Priročnik za hitri zagon
Kratke upute

Руководство по быстрой установке
Коротка інструкція "Початок роботи"
Қысқаша іске қосу нұсқаулығы
빠른 시작 가이드
دليل البداية السريعة
Panduan Ringkas
設定手冊
設定説明書



Included items

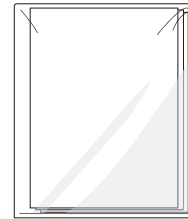
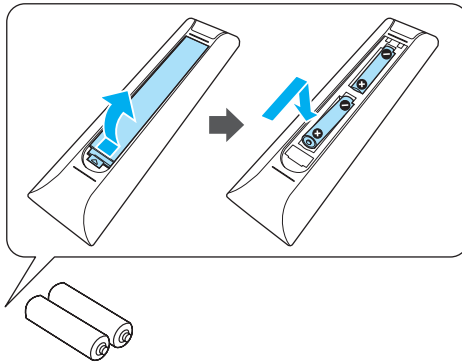
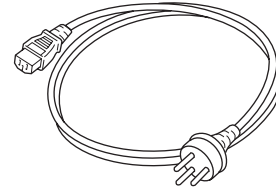
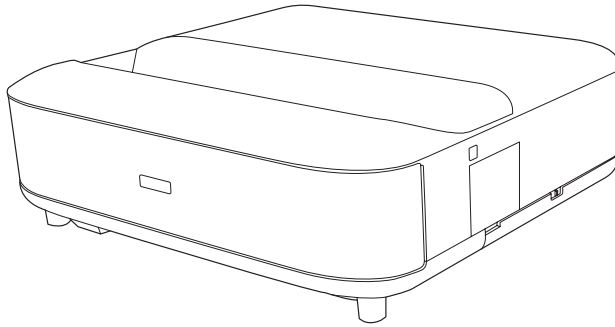

Connecting

eARC/ARC compatible AV system

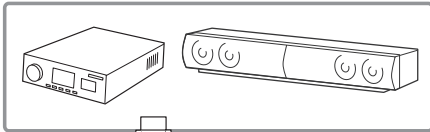

Ethernet compatible HDMI cable



HDMI 2 (eARC/ARC)

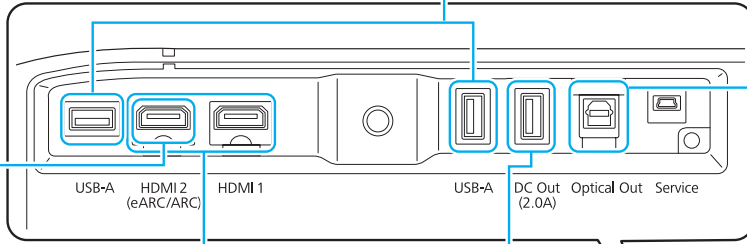

USB-A

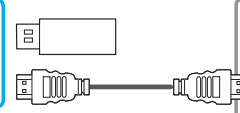

Optical Out

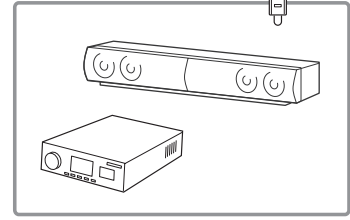
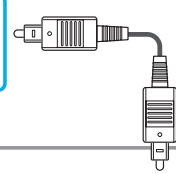

HDMI 1
HDMI2 (eARC/ARC)

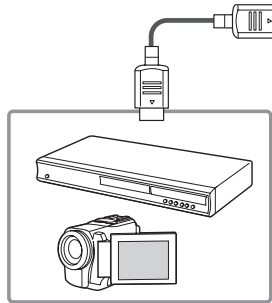

DC Out (2.0A)

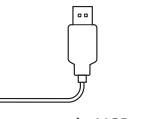

メディアストリーミング端末

Power supply USB cable

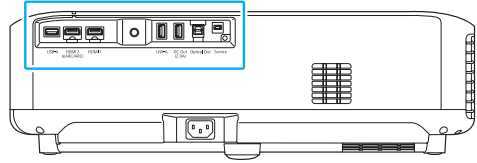

1 Install the projector

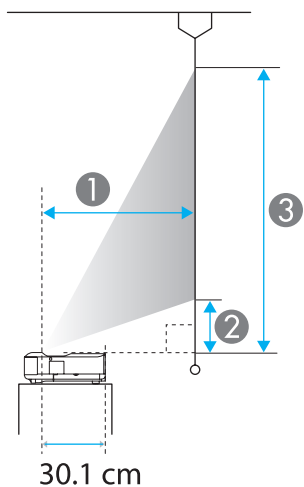

16:9 screen size	①	②	③
80" (177 x 100 cm)	45.1 cm	17.5 cm	117.1 cm
100" (221 x 125 cm)	57.7 cm	23.5 cm	148.0 cm
120" (266 x 149 cm)	70.3 cm	29.4 cm	178.8 cm

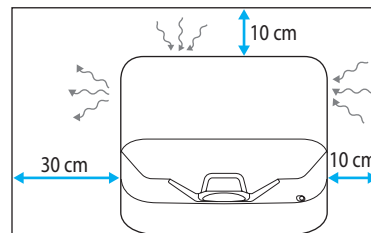
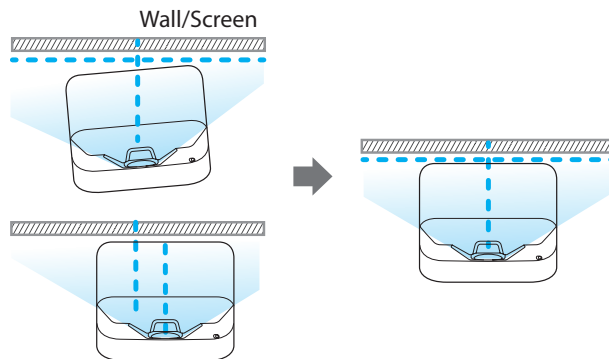

2 Turn on the projector

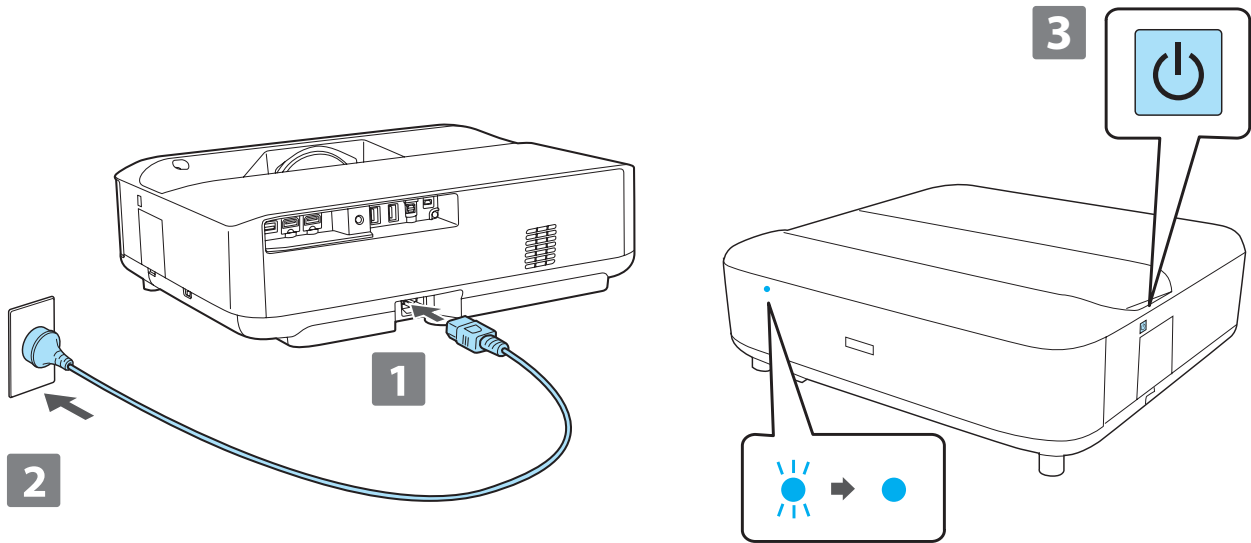

3 Adjust the image

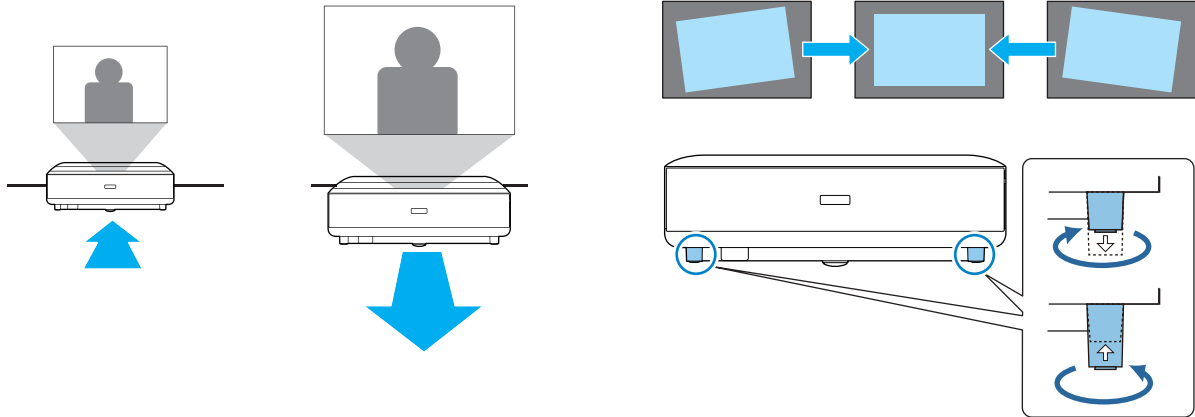

4 Adjust the focus

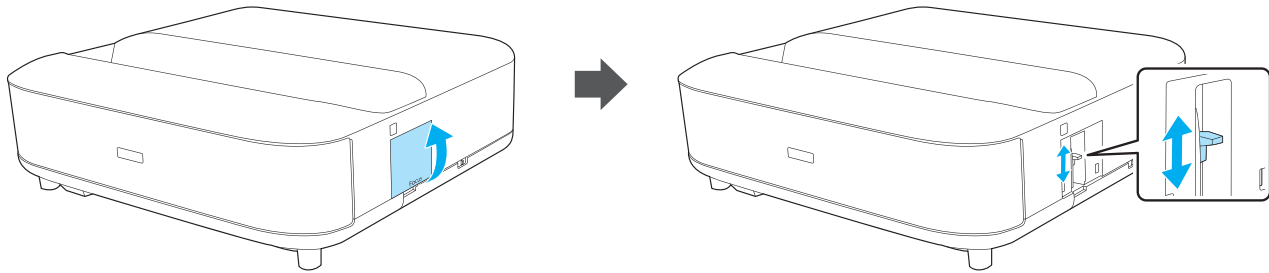
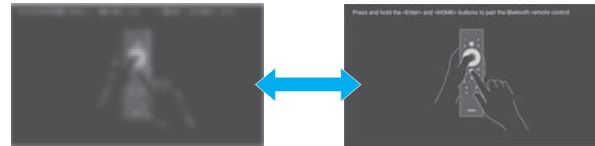

5 Pair the remote control & Select your language

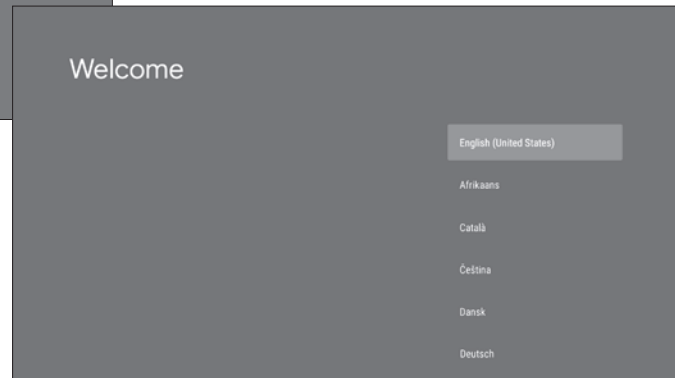
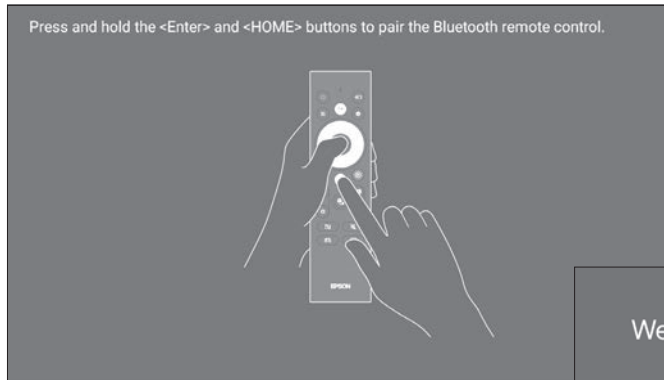

6 Correct the image shape

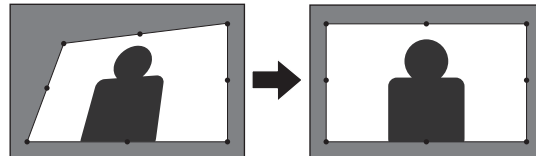

1

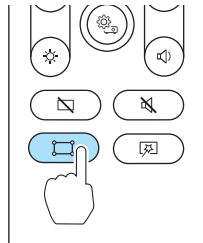

2



For more information



epson.sn 🔍

<http://epson.sn>



EN	See the “User’s Guide” on the Epson Web site for detailed instructions and specifications.
DE	Beachten Sie die Bedienungsanleitung auf der Epson-Website für detaillierte Anweisungen und technische Daten.
FR	Consultez le “Guide de l’utilisateur” sur le site Web d’Epson afin d’obtenir les instructions et les caractéristiques détaillées.
IT	Per istruzioni e specifiche dettagliate, vedere la “Manuale dell’utente” sul sito Web Epson.
ES	Consulte la “Manual de usuario” en el sitio web de Epson para obtener instrucciones y especificaciones detalladas.
PT	Consulte instruções e especificações detalhadas no “Manual do utilizador” no website da Epson.
NL	Raadpleeg de “Gebruikershandleiding” op de website van Epson voor gedetailleerde instructies en specificaties.
DA	Du kan finde yderligere vejledninger og specifikationer i afsnittet “Brugerhåndbog” på Epsons hjemmeside.
FI	Katso Epson-verkkosivuston “Käyttäjän opas” -kohdasta yksityiskohtaiset tiedot ja tekniset tiedot.
NO	Se «Brukerhåndbok» på Epsons nettsted for detaljerte instruksjoner og spesifikasjoner.
SV	Se “Bruksanvisning” på Epsons webbplats för utförliga instruktioner och specifikationer.
CS	Podrobné pokyny a specifikace najdete v dokumentu „Uživatelská příručka“ na webu společnosti Epson.

HU	A részletes utasításokért és specifikációkért lásd a „Használati útmutató” dokumentumot az Epson webhelyén.
PL	Sprawdź „Przewodnik użytkownika” na stronie internetowej Epson w celu uzyskania szczegółowych instrukcji i specyfikacji.
SK	Podrobné pokyny a špecifikácie nájdete v „Používateľská príručka” na webovej stránke spoločnosti Epson.
RO	Consultați „Ghidul utilizatorului” de pe site-ul web Epson pentru instrucțiuni și specificații detaliate.
EL	Ανατρέξτε στον «Εγχειρίδιο χρήσης» στην ιστοσελίδα της Epson για λεπτομερείς οδηγίες και προδιαγραφές.
TR	Ayrıntılı talimatlar ve teknik özellikler için Epson Web sitesindeki “Kullanım Kılavuzu”na bakın.
SL	Za podrobna navodila in tehnične podatke si oglejte »Priročnik za uporabnika« na spletnem mestu družbe Epson.
HR	Pogledajte “Priručnik za uporabu” na Epsonovoj web-stranici s detaljnim uputama i tehničkim podacima.
RU	Подробные инструкции и технические характеристики см. в «Руководство по эксплуатации» на веб-сайте Epson.
UK	Детальну інструкцію та технічні характеристики див. у «Посібник користувача» на веб-сайті Epson.
KK	Толық нұсқаулар мен сипаттамаларды Epson веб-сайтындағы “Пайдаланушы нұсқаулығы” құжатынан қараңыз.
KO	자세한 지침과 사양은 Epson 웹 사이트의 “사용자 가이드” 를 참조하십시오.
AR	راجع «دليل المستخدم» في موقع Epson على الويب للاطلاع على التعليمات التفصيلية والموصفات.
ID	Lihat Panduan Pengguna di situs web Epson untuk rincian instruksi dan spesifikasi.
ZHS	请参见 Epson 网站中的“使用说明书”了解详细说明和规格。
ZHT	關於詳細的說明與規格，請參考 Epson 網站上的「使用說明書」。

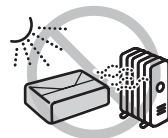



EPSON is a registered trademark of Seiko Epson Corporation.

Google and Android TV are trademarks of Google LLC.

Google Assistant is not available in certain languages and countries.

Availability of services varies by country and language.

Manufactured under license from Dolby Laboratories. Dolby, Dolby Audio, and the double-D symbol are trademarks of Dolby Laboratories.

HDMI, the HDMI Logo and High-Definition Multimedia Interface are trademarks or registered trademarks of HDMI Licensing Administrator, Inc.

© 2023 Seiko Epson Corporation



414418200