

EPSON®

EB-L30002U

EB-L30000U

Specifications

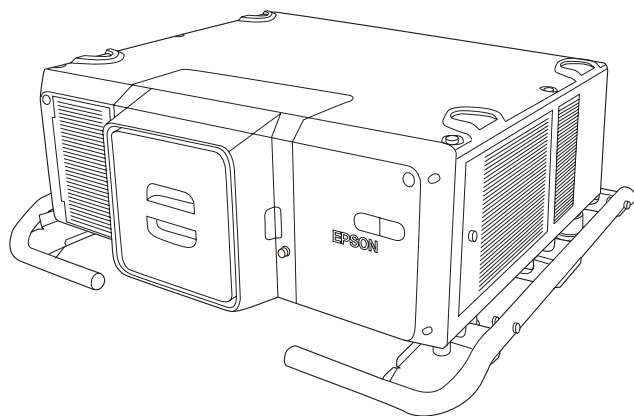

Contents

- **Product Overview** 3
- **Dimensions** 6
- **Connector Ports** 13
- **Remote Control Operating Range (Wireless)** 14
- **Angle of View for Built-in Camera** 14
- **Screen Size and Projection Distance** 15
- **Lens Compatibility Table** 20
- **Supported Resolutions** 21
- **Available Lens Shift Adjustment Range**..... 23
- **Available Keystone Correction Range** 25
- **Curved Surface Correction Range for Camera Assist** 30
- **Installation Angle** 33
- **Installation Range** 33
- **Serial Connection** 34
- **Monitoring and Control**..... 35
- **Image Maintenance** 54
- **Cautions** 55
- **Disclaimer** 55

■ Product Overview

This product has high luminance and high luminous flux, optimal for projecting in a large space such as a lecture hall or a large conference room. The projector offers the following useful features.

- Flexible installation with 360 degree projection.
- A variety of adjustment features such as Geometry Correction and Edge Blending.
- A laser light source that reduces the time needed for maintenance and the risk of interruptions due to the light source suddenly turning off.
- You can use it in smoky environments such as at events that use dry ice machines.

Product Specifications

Product name		EB-L30002U	EB-L30000U
Projection system		RGB liquid crystal shutter	
Brightness ^{1,2}		Normal: 30,000 lm Quiet/Extended: 21,000 lm	
Contrast ratio ²		2,500,000: 1 (Dynamic Contrast: Normal/High Speed)	
Supported RGB signal resolutions		WUXGA ³ , UXGA, WSXGA+, SXGA+, SXGA, WXGA++, WXGA+, WXGA, XGA, SVGA, VGA	
Supported video signals		Component: HDTV (1080i/1080p ⁴), HDTV (720p), SDTV (576i/576p), SDTV (480i/480p)	
Supported digital signals		WQXGA ^{3,5} , WQHD ⁵ , QXGA ⁵ , WUXGA ³ , UXGA, WSXGA+, SXGA+, SXGA, WXGA++, WXGA+, WXGA, XGA, SVGA, VGA, 4K (SMPTE) ⁵ , 4K ⁵ , HDTV (1080i/1080p), HDTV (720p), SDTV (576i/576p), SDTV (480i/480p)	
Pixel number (Width × Height × Number of LCDs)		1,920 × 1,200 × 3	
LCD panel size (diagonal)		1.43" Wide	
Color reproducibility		Max. 1,070 million colors (Depends on the interface)	
Scanning frequency	Analog	Horizontal: 15.63 - 91.15 kHz Vertical: 50/59.94/60/70/72/75/85 Hz	
	HDMI/HDBaseT	Horizontal: 15.63 - 135.00 kHz Vertical: 23.98/24/25/29.97/30/50/59.94/60 Hz	
	DVI-D	Horizontal: 15.63 - 75.00 kHz Vertical: 23.98/24/29.97/30/50/59.94/60 Hz	
	SDI	Horizontal: 15.63 - 67.50 kHz Vertical: 23.98/24/25/29.97/30/50/59.94/60 Hz 3G-SDI (YCbCr 4:2:2 10bit) supported	
Projection lens		Optional lens supported	
Adjust zoom		Automatic	
Zoom rate ¹		1 - 1.35	
Adjust focus		Automatic	
Lens shift range ⁶		Vertical approx. 65%, horizontal approx. 30% ⁷	
Dimensions (W × H × D) mm		790 × 299 × 710 (not including raised section)	

Product name		EB-L30002U	EB-L30000U
Mass (without handles)*1		Approx. 64.2 kg	Approx. 63.8 kg
Light source		Laser diode	
Light source output		Maximum 40.6 W x 20 (812 W)	
Wavelength		450 to 460 nm	
Light source life expectancy*8		Approx. 20,000 hours (Light Source Mode: Normal, Quiet) Approx. 30,000 hours (Light Source Mode: Extended)	
Operating temperature*9		Altitude of 0 to 2,286 m: 0 to +50°C (Humidity of 20 to 80%, No condensation) Altitude of 2,287 to 3,048 m: 0 to +45°C (Humidity of 20 to 80%, No condensation)	
Power supply		100 to 120 V AC±10 50/60 Hz 9.2 A 200 to 240 V AC±10 50/60 Hz 12.0 A	
Power consumption	110 to 120 V	Rated power consumption: 895 W Standby power consumption (Communication On): 2.5 W Standby power consumption (Communication Off): 0.5 W	
	200 to 240 V	Rated power consumption: 2,325 W Standby power consumption (Communication On): 2.5 W Standby power consumption (Communication Off): 0.5 W	
Noise level*2		Normal: 49 dB Quiet: 41 dB	
Dissipation BTU (max.)		100 to 120 V 3,043 BTU/h 200 to 240 V 7,905 BTU/h	
Air flow (max.)		520 CFM	
Image input ports		Mini D-Sub15pin ×1, 5BNC×1, BNC (SDI) ×1, HDMI*10 ×1, DVI-D 24pin ×1, HDBaseT*10 ×1	
Image output port		Mini D-Sub15pin ×1, BNC (SDI)×1	
Network		RJ45 (100BASE-TX/10BASE-T) ×1 USB connector (A type) ×1 (for wireless LAN unit*11 corresponding to IEEE802.11b/g/n)	
Control ports		RJ45*12 ×1, Mini D-Sub 9-pin ×1 (RS-232C), stereo mini ×1 (for wired remote control), HDBaseT*12 ×1, USB connector (Type-B) ×1, USB connector (Type-A) ×1	
Functions Others		Geometry Correction function, Edge Blending, 360 Degree Projection, Schedule, Shutter, Split Screen, Frame Interpolation, 4K Enhancement, Multi-Projection, Auto Color Adjustment, Password Protection, Memory function, Lens Position Memory, Direct Power On, Direct Shutdown, Network Projection function	

*1 The specifications are when the ELPLM12 is attached.

*2 All average values for this product at time of shipping comply with the ISO 21118 international standards. Measurement conditions are based on the measuring method in Appendix 2 in the guide supplied.

*3 Only VESA CVT-RB (Reduced Blanking) signals are supported.

*4 Only supports input signals from the Computer input port.

- *5 Only supports input signals from the HDMI or HDBaseT port.
- *6 The lens cannot be shifted to the maximum in all four directions.
- *7 A maximum of approx. 55% up and down, and 25% left and right for the ELPLU05/ELPLL09/ELPLL10, and a maximum of approx. 15% up and down, and 5% left and right for the ELPLR05.
- *8 Approximate time until light source brightness is reduced by half.
(Assuming the projector is used in an atmosphere in which airborne particulate matter is less than 0.04 to 0.2 mg/m³. The estimated time varies depending on the projector usage and operating conditions.)
- *9 When the environmental temperature rises, the light source's brightness is slowly reduced. (Approximately 40°C at an altitude of 0 to 2,286 m, and approximately 35°C at an altitude of 2,287 to 3,048 m; however, this may vary depending on the surroundings and so on.)
The projector may turn off automatically if the operating temperature range is exceeded.
- *10 HDCP 2.2 is supported.
- *11 The wireless LAN unit is an optional accessory.
- *12 Art-Net is supported.

Values are just reference.

Lens Specifications

Lens Model Number	Amount of lens protrusion (mm) ^{*1}	Lens Mass	F value	f (mm)	Zoom Rate	Optical Power Comparison ^{*2}
ELPLX03	(100)	13,000 g	2.2	11.16	-	73%
ELPLR05	45.8	9,600 g	2.2	19.1	-	84%
ELPLU05	41.4	9,400 g	2.4 - 2.6	28.4 - 34.0	1.2	84%
ELPLW07	38.8	9,500 g	2.2 - 2.5	40.6 - 55.2	1.4	92%
ELPLM12	0.3	7,700 g	1.9 - 2.1	54.7 - 73.0	1.4	100%
ELPLM13	22.3	8,000 g	1.9 - 2.4	71.6 - 107.3	1.5	98%
ELPLM14	12.3	8,700 g	2.1 - 2.4	106.8 - 160.9	1.5	94%
ELPLL09	26.4	9,700 g	2.1 - 2.5	149.7 - 225.0	1.5	92%
ELPLL10	62.2	10,900 g	2.2 - 2.6	216.6 - 326.8	1.5	93%

*1 The length from the front of the projector to the apex of the lens.

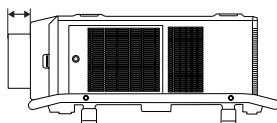

*2 When the position of the lens is in the home position, zoom is at its maximum value.

■ Dimensions

[Units: mm]

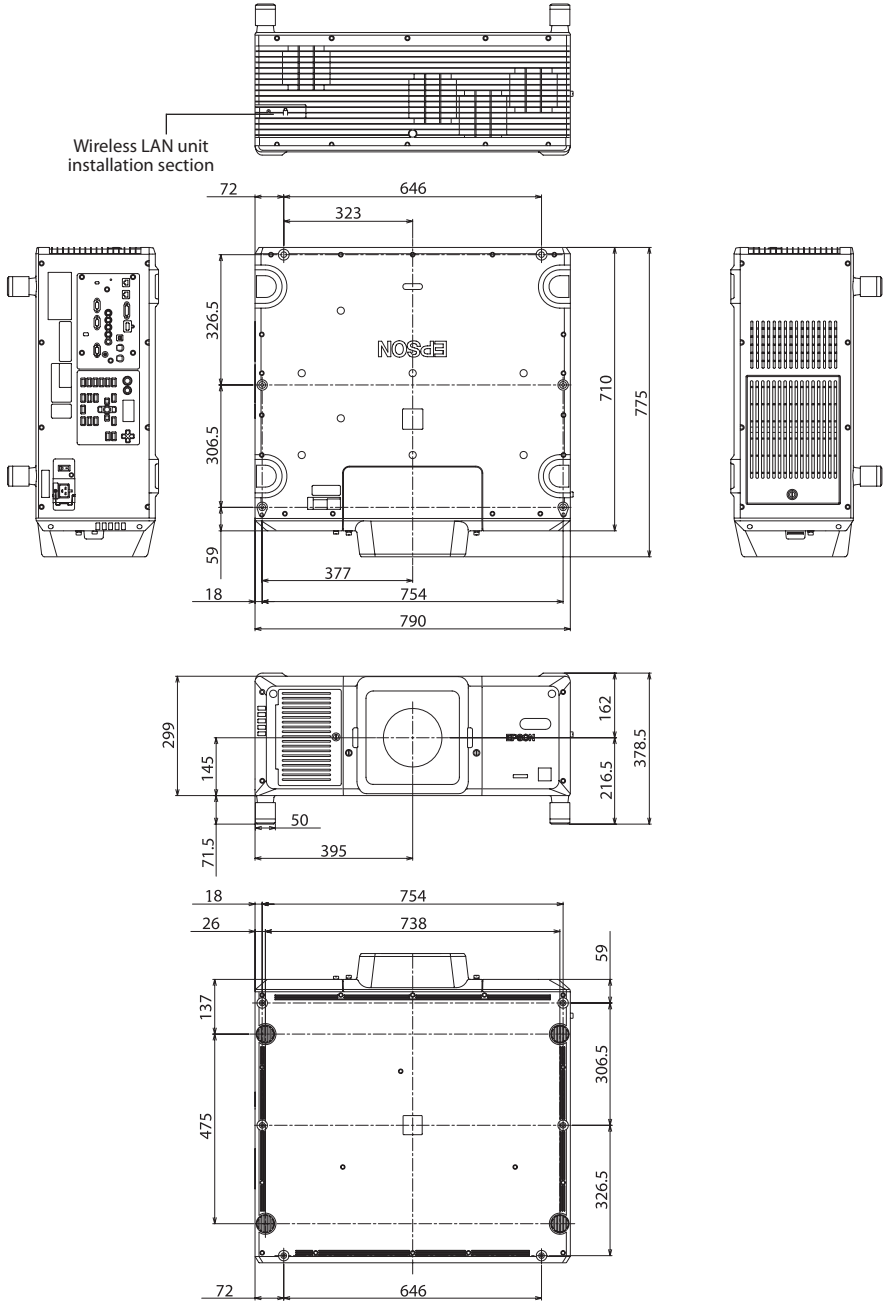

With a Handle

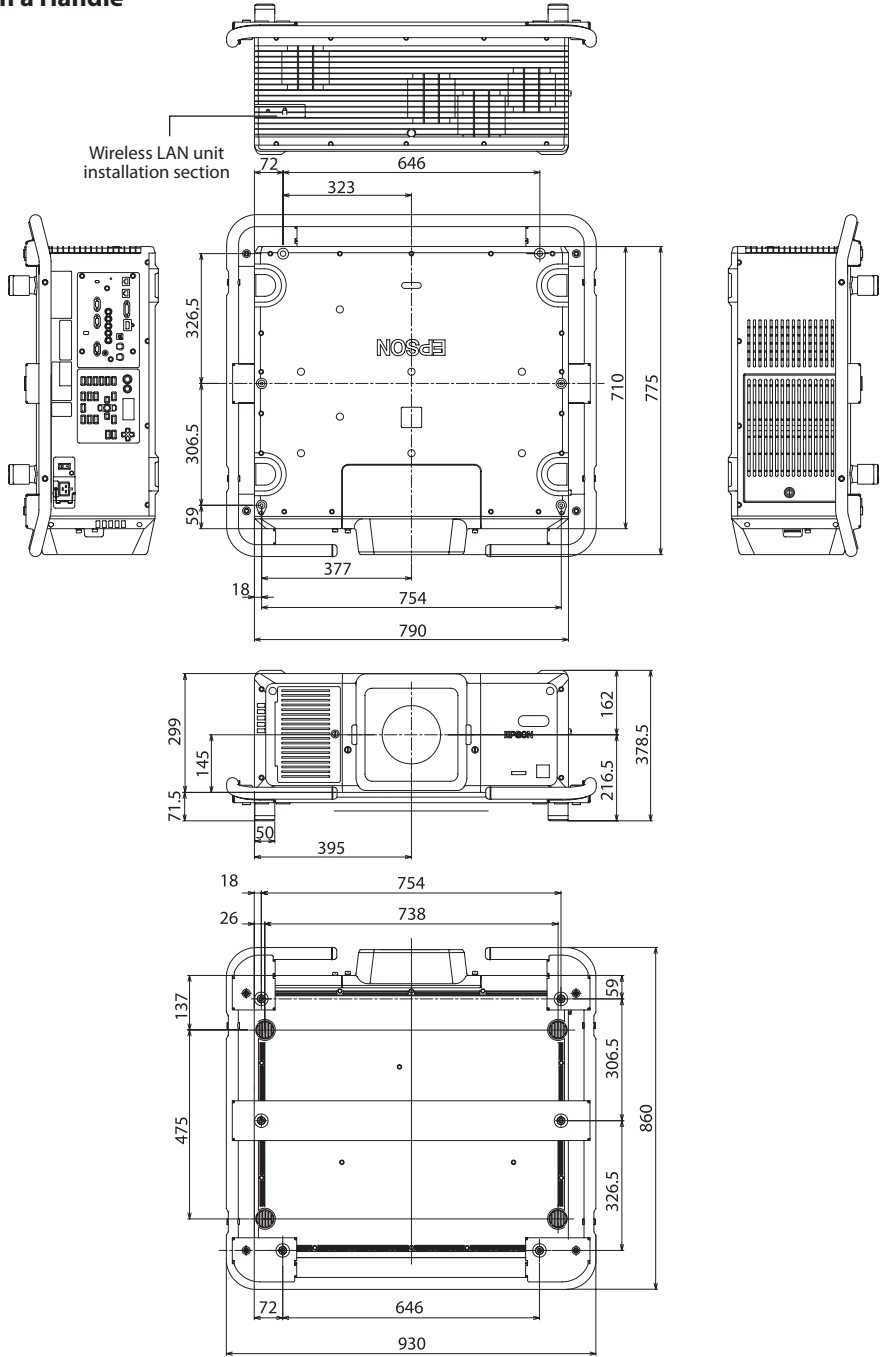

Portrait Projection

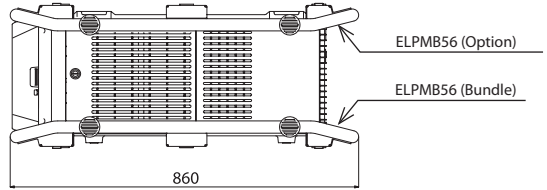
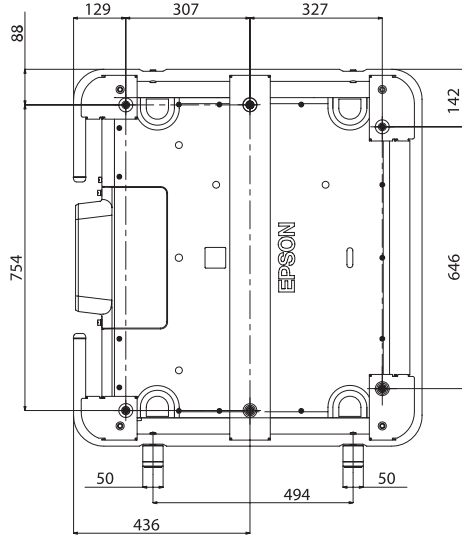
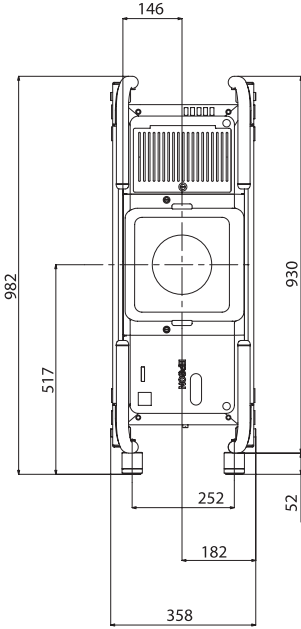

When lens unit ELPLX03 is installed

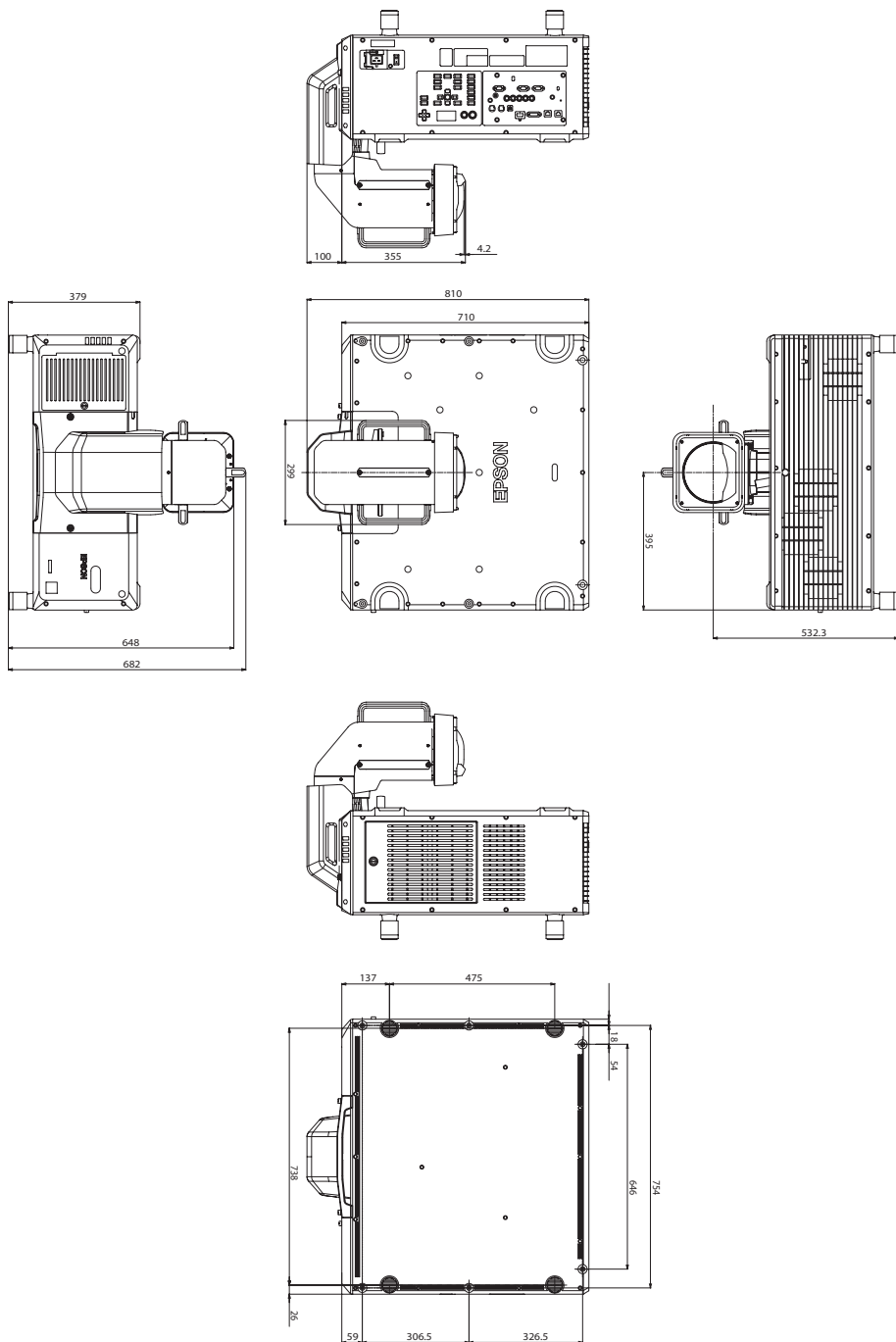

Handle Securing Section

There are six installation points on the ceiling surface and the base surface.

This allows installation of the optional handles (ELPMB56) and the metallic mounts prepared by the customer.

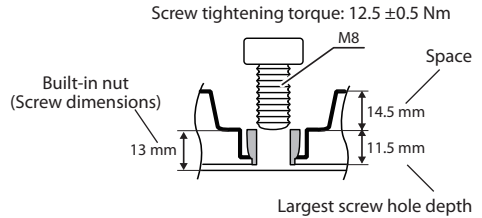
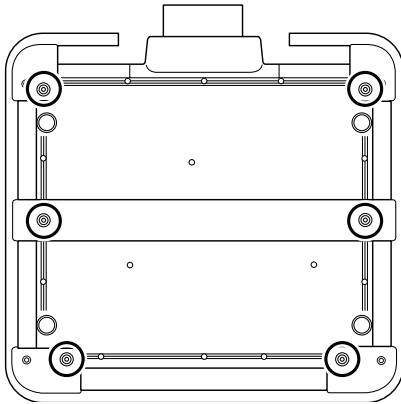
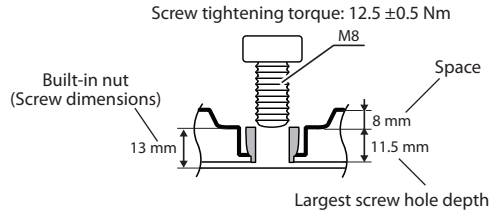
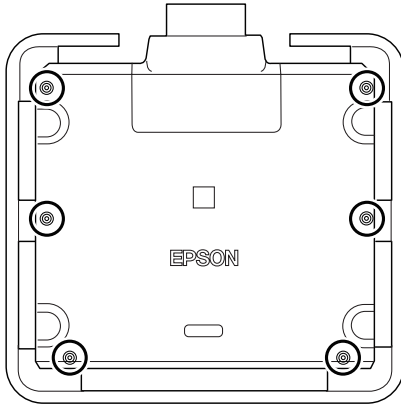

When handles are installed on the top and bottom of the projector, you can install the projector vertically and perform portrait projection.

When performing portrait projection, make sure you remove the projector feet and screw them into the holes next to the handles.

Do not install anything other than the projector's feet (such as metallic mounts and so on) in these holes.

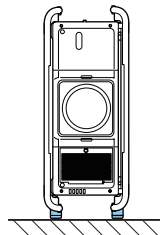
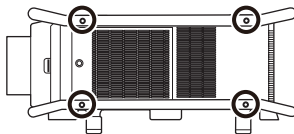

Note the following points when installing a projector directly on top of another. This projector can be installed on top of another projector that has the carrying handle (ELPMB56) attached to the top.

- Do not stack three or more projectors (you can stack up to two projectors).
- Install the feet in the indentations on the top at the four corners.
- Do not remove the feet on the bottom of the projector.

Cautions on Lifting

To lift the projector, attach eye bolts to the four points on the same surface of the projector. Attach the eye bolts to the following points.

- When attaching directly to the projector
Use four commercially available eye bolts M8 (ankle length 11 to 16 mm) and attach them to the four screw holes for eye bolts.

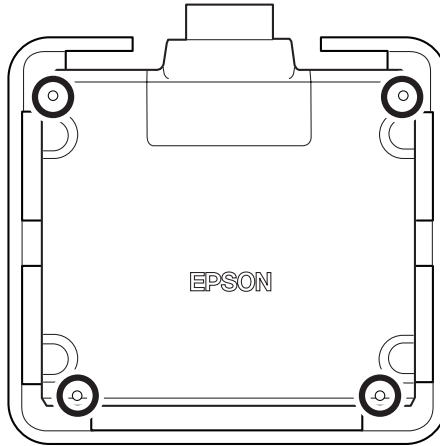

- When attaching to the handle
Use four commercially available eye bolts M10 (ankle length 11 mm or more) and attach them to the four screw holes for eye bolts on the handle.

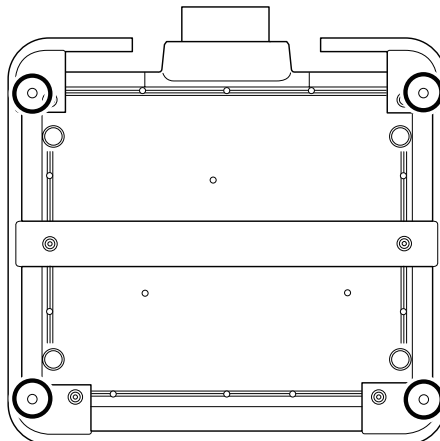

Do not lift the projector with the front/back/side of the projector facing up. Make sure that the angle when lifting is 60 degrees or more.

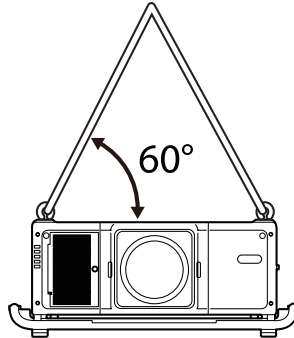

Only use the eye bolts when temporarily transporting the projector and not for permanent installation.

Connector Ports

* Location of the connection ports on the projector

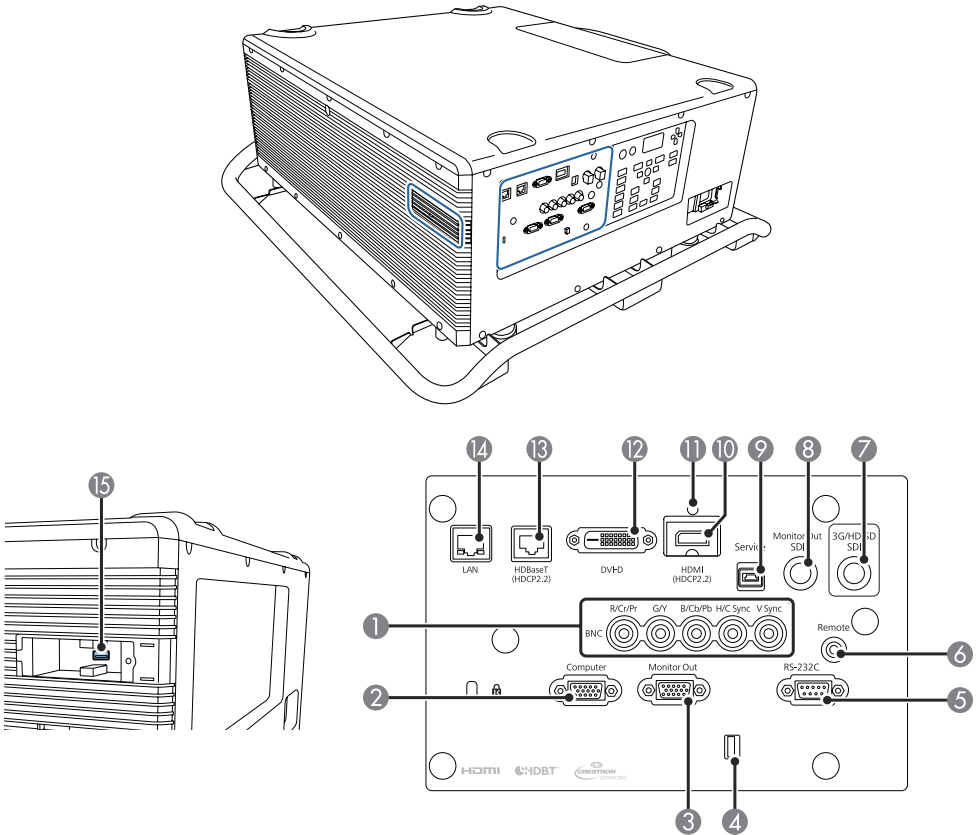

No.	Name	No.	Name
①	BNC input port (5BNC)	⑨	Service port (USB Type-B) ^{*2,*3}
②	Computer input port (Mini D-Sub15-pin)	⑩	HDMI input port (HDMI HDCP) ^{*4}
③	Monitor Out port (Mini D-Sub15-pin) ^{*1}	⑪	Cable holder
④	Cable holder	⑫	DVI-D input port (DVI-D 24-pin)
⑤	RS-232C port (Mini D-Sub 9-pin)	⑬	HDBaseT port (HDBaseT RJ45) ^{*4,*5}
⑥	Remote port (stereo mini)	⑭	LAN port (RJ45: 100Base-TX)
⑦	3G/HD/SD SDI input port (BNC)	⑮	USB-A port (USB Type-A) ^{*2,*3,*6}
⑧	Monitor out SDI output port (BNC)		

*1 Only analog RGB signals can be output from the BNC port and the Computer port.

*2 USB 2.0 is supported. We cannot guarantee that all USB devices will operate correctly.

*3 Use to copy menu settings using the batch setup function.

*4 HDCP 2.2 is supported.

*5 Make sure you use LAN cables that are straight STP cables, category 6 or higher, and recommended by the HDBaseT Alliance.

*6 Maximum of 900 mA when power is being supplied. Connect to this port when connecting the optional wireless LAN unit. Connect to this port to save the projector's operation logs to a USB flash drive.

Remote Control Operating Range (Wireless)

The following shows the operation range for the remote control supplied with the projector.

Left/Right

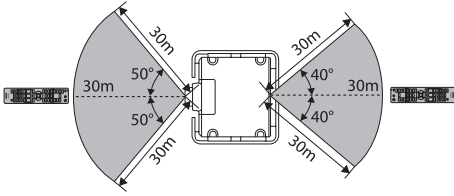

Up/Down

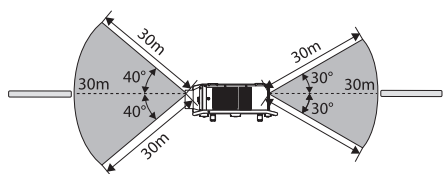

When the Handle (ELPMB56) Is Installed at the Top

Left/Right

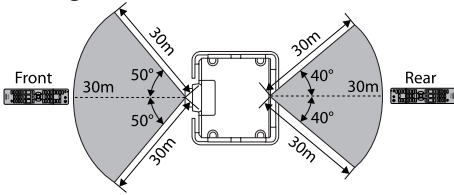

Up/Down

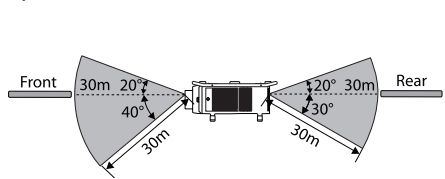

Angle of View for Built-in Camera

The following shows the angle of view for the projector's built-in camera.

Left/Right

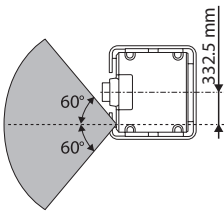

Up/Down

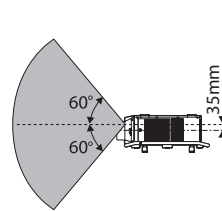

■ Screen Size and Projection Distance

See page 6 for the distances of each part of the projector.

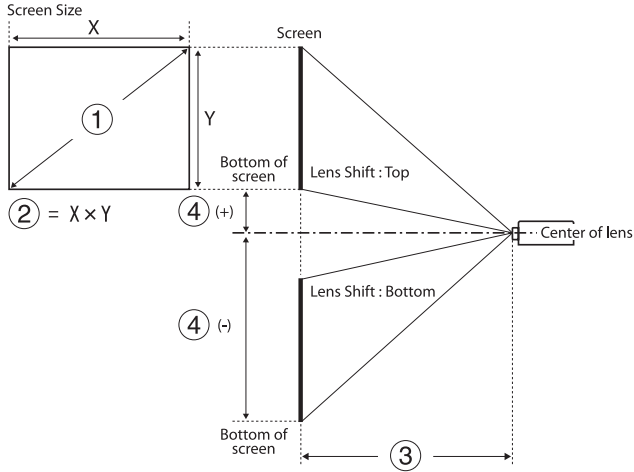

① Screen size (inches)

② Screen size (width x height)

③ Projection distance (Minimum: Wide to Maximum: Tele)

④ Distance from the center of the lens to the bottom of the screen

Projection Distance Formula by Lens

<For screens with an aspect ratio of 16:10>

Projection lens	Projection Distance ③ Formula		Throw Ratio(③ /x)
ELPLX03	Minimum	Projection distance (cm)= Projection screen size (inches) x 0.78-4.24	0.35
ELPLR05	Minimum	Projection distance (cm)= Projection screen size (inches) x 1.35-10.18	0.60
	Maximum	Projection distance (cm)= Projection screen size (inches) x 1.35-10.18	
ELPLU05	Minimum	Projection distance (cm)= Projection screen size (inches) x 1.98-7.56	0.90 - 1.09
	Maximum	Projection distance (cm)= Projection screen size (inches) x 2.39-7.35	
ELPLW07	Minimum	Projection distance (cm)= Projection screen size (inches) x 2.82-10.15	1.29 - 1.76
	Maximum	Projection distance (cm)= Projection screen size (inches) x 3.85-10.49	
ELPLM12	Minimum	Projection distance (cm)= Projection screen size (inches) x 3.81-12.74	1.74 - 2.35
	Maximum	Projection distance (cm)= Projection screen size (inches) x 5.12-12.04	
ELPLM13	Minimum	Projection distance (cm)= Projection screen size (inches) x 4.99-17.44	2.28 - 3.46
	Maximum	Projection distance (cm)= Projection screen size (inches) x 7.54-16.08	
ELPLM14	Minimum	Projection distance (cm)= Projection screen size (inches) x 7.14+41.07	3.41 - 5.12
	Maximum	Projection distance (cm)= Projection screen size (inches) x 10.84+39.76	
ELPLL09	Minimum	Projection distance (cm)= Projection screen size (inches) x 10.10+43.96	4.79 - 7.20
	Maximum	Projection distance (cm)= Projection screen size (inches) x 15.30+43.65	
ELPLL10	Minimum	Projection distance (cm)= Projection screen size (inches) x 14.63+70.47	6.96 - 10.45
	Maximum	Projection distance (cm)= Projection screen size (inches) x 22.16+68.69	

Distance from the center of the lens to the base of the screen (ELPLX03):

④ (+) (cm) = screen size (inches) x 0.27

④ (-) (cm) = screen size (inches) x -0.67

Distance from the center of the lens to the base of the screen (ELPLR05):

④ (+) (cm) = screen size (inches) x -0.90

④ (-) (cm) = screen size (inches) x -0.44

Distance from the center of the lens to the base of the screen (ELPLU05/ELPLL09/ELPLL10):

④ (+) (cm) = screen size (inches) x -1.42

④ (-) (cm) = screen size (inches) x 0.07

Distance from the center of the lens to the base of the screen (ELPLW07/ELPLM12/ELPLM13/ELPLM14):

④ (+) (cm) = screen size (inches) x -1.55

④ (-) (cm) = screen size (inches) x 0.20

<For screens with an aspect ratio of 16:9>

Projection lens	Projection Distance ③ Formula		Throw Ratio(③ /x)
ELPLX03	Minimum	Projection distance (cm)= Projection screen size (inches) x 0.80-4.24	0.35
ELPLR05	Minimum	Projection distance (cm)= Projection screen size (inches) x 1.39-10.18	0.60
	Maximum	Projection distance (cm)= Projection screen size (inches) x 1.39-10.18	
ELPLU05	Minimum	Projection distance (cm)= Projection screen size (inches) x 2.04-7.56	0.90 - 1.09
	Maximum	Projection distance (cm)= Projection screen size (inches) x 2.46-7.35	
ELPLW07	Minimum	Projection distance (cm)= Projection screen size (inches) x 2.90-10.15	1.29 - 1.76
	Maximum	Projection distance (cm)= Projection screen size (inches) x 3.96-10.49	
ELPLM12	Minimum	Projection distance (cm)= Projection screen size (inches) x 3.91-12.74	1.74 - 2.35
	Maximum	Projection distance (cm)= Projection screen size (inches) x 5.26-12.04	
ELPLM13	Minimum	Projection distance (cm)= Projection screen size (inches) x 5.13-17.44	2.28 - 3.46
	Maximum	Projection distance (cm)= Projection screen size (inches) x 7.75-16.08	

Projection lens	Projection Distance ③ Formula		Throw Ratio(③ /x)
ELPLM14	Minimum	Projection distance (cm)= Projection screen size (inches) x 7.34+41.07	3.41 - 5.12
	Maximum	Projection distance (cm)= Projection screen size (inches) x 11.14+39.76	
ELPLL09	Minimum	Projection distance (cm)= Projection screen size (inches) x 10.38+43.96	4.79 - 7.20
	Maximum	Projection distance (cm)= Projection screen size (inches) x 15.72+43.65	
ELPLL10	Minimum	Projection distance (cm)= Projection screen size (inches) x 15.04+70.47	6.96 - 10.45
	Maximum	Projection distance (cm)= Projection screen size (inches) x 22.77+68.69	

Distance from the center of the lens to the base of the screen (ELPLX03):

④ (+) (cm) = screen size (inches) x 0.35

④ (-) (cm) = screen size (inches) x 0

Distance from the center of the lens to the base of the screen (ELPLR05):

④ (+) (cm) = screen size (inches) x -0.86

④ (-) (cm) = screen size (inches) x -0.38

Distance from the center of the lens to the base of the screen (ELPLU05/ELPLL09/ELPLL10):

④ (+) (cm) = screen size (inches) x -1.39

④ (-) (cm) = screen size (inches) x 0.14

Distance from the center of the lens to the base of the screen (ELPLW07/ELPLM12/ELPLM13/ELPLM14):

④ (+) (cm) = screen size (inches) x -1.52

④ (-) (cm) = screen size (inches) x 0.28

<For screens with an aspect ratio of 4:3>

Projection lens	Projection Distance ③ Formula		Throw Ratio(③ /x)
ELPLX03	Minimum	Projection distance (cm)= Projection screen size (inches) x 0.88-4.24	0.42
ELPLR05	Minimum	Projection distance (cm)= Projection screen size (inches) x 1.53-10.18	0.73
	Maximum	Projection distance (cm)= Projection screen size (inches) x 1.53-10.18	
ELPLU05	Minimum	Projection distance (cm)= Projection screen size (inches) x 2.25-7.56	1.08 - 1.31
	Maximum	Projection distance (cm)= Projection screen size (inches) x 2.71-7.35	
ELPLW07	Minimum	Projection distance (cm)= Projection screen size (inches) x 3.19-10.15	1.54 - 2.12
	Maximum	Projection distance (cm)= Projection screen size (inches) x 4.36-10.49	
ELPLM12	Minimum	Projection distance (cm)= Projection screen size (inches) x 4.31-12.74	2.09 - 2.82
	Maximum	Projection distance (cm)= Projection screen size (inches) x 5.79-12.04	
ELPLM13	Minimum	Projection distance (cm)= Projection screen size (inches) x 5.65-17.44	2.73 - 4.16
	Maximum	Projection distance (cm)= Projection screen size (inches) x 8.54-16.08	
ELPLM14	Minimum	Projection distance (cm)= Projection screen size (inches) x 8.09+41.07	4.09 - 6.15
	Maximum	Projection distance (cm)= Projection screen size (inches) x 12.27+39.76	
ELPLL09	Minimum	Projection distance (cm)= Projection screen size (inches) x 11.43+43.96	5.75 - 8.64
	Maximum	Projection distance (cm)= Projection screen size (inches) x 17.32+43.65	
ELPLL10	Minimum	Projection distance (cm)= Projection screen size (inches) x 16.56+70.47	8.35 - 12.54
	Maximum	Projection distance (cm)= Projection screen size (inches) x 25.08+68.69	

Distance from the center of the lens to the base of the screen (ELPLX03):

④ (+) (cm) = screen size (inches) x 0.30

④ (-) (cm) = screen size (inches) x -0.08

Distance from the center of the lens to the base of the screen (ELPLR05):

④ (+) (cm) = screen size (inches) x -1.02

④ (-) (cm) = screen size (inches) x -0.50

Distance from the center of the lens to the base of the screen (ELPLU05/ELPLL09/ELPLL10):

④ (+) (cm) = screen size (inches) x -1.60

④ (-) (cm) = screen size (inches) x 0.08

Distance from the center of the lens to the base of the screen (ELPLW07/ELPLM12/ELPLM13/ELPLM14):

④ (+) (cm) = screen size (inches) x -1.75

④ (-) (cm) = screen size (inches) x 0.23

Projection Distance Formulas

The projection distances are approximate values.

Visit the following Web site to find the projection distance calculator.

<http://www.epson.com/>

<For screens with an aspect ratio of 16:10>

[Units: cm]

①	②	③								④		
Inches (Diagonally)	Width x Height	ELPLR05	ELPLU05	ELPLW07	ELPLM12	ELPLM13	ELPLM14	ELPLL09	ELPLL10	ELPLR05	ELPLU05/ ELPLL09/ ELPLL10	ELPLW07/ ELPLM12/ ELPLM13/ ELPLM14
100	215 x 135	125 - 125	191 - 232	272 - 375	368 - 500	482 - 738	756 - 1123	1054 - 1574	1533 - 2284	-90 - -44	-142 - +7	-155 - +20
200	431 x 269	260 - 260	389 - 472	554 - 760	749 - 1011	981 - 1492	1470 - 2207	2064 - 3103	2997 - 4500	-181 - -88	-283 - +14	-310 - +41
300	646 x 404	396 - 396	588 - 711	836 - 1145	1129 - 1523	1480 - 2247	2184 - 3291	3073 - 4633	4460 - 6716	-271 - -133	-425 - +21	-465 - +61
400	862 x 538	531 - 531	786 - 950	1119 - 1530	1510 - 2034	1980 - 3001	2899 - 4374	4083 - 6163	5923 - 8931	-362 - -177	-567 - +28	-620 - +81
500	1077 x 673	666 - 666	984 - 1190	1401 - 1915	1891 - 2546	2479 - 3755	3613 - 5458	5093 - 7693	7386 - 11147	-452 - -221	-708 - +35	-775 - +102
600	1292 x 808	801 - 801	1183 - 1429	1683 - 2300	2272 - 3057	2978 - 4509	4328 - 6542	6103 - 9223	8849 - 13363	-543 - -265	-850 - +42	-930 - +122
700	1508 x 942	936 - 936	1381 - 1669	1965 - 2685	2652 - 3569	3477 - 5263	5042 - 7625	7113 - 10753	10312 - 15578	-633 - -309	-991 - +49	-1085 - +142
800	1723 x 1077	1072 - 1072	1580 - 1908	2247 - 3070	3033 - 4080	3977 - 6018	5757 - 8709	8123 - 12283	11775 - 17794	-724 - -353	-1133 - +56	-1240 - +163
900	1939 x 1212	1207 - 1207	1778 - 2148	2530 - 3455	3414 - 4592	4476 - 6772	6471 - 9793	9133 - 13813	13238 - 20010	-814 - -398	-1275 - +63	-1395 - +183
1000	2154 x 1346	1342 - 1342	1977 - 2387	2812 - 3840	3794 - 5103	4975 - 7526	7186 - 10876	10142 - 15342	14701 - 22225	-904 - -442	-1416 - +70	-1550 - +203

<For screens with an aspect ratio of 16:9>

[Units: cm]

①	②	③								④		
Inches (Diagonally)	Width x Height	ELPLR05	ELPLU05	ELPLW07	ELPLM12	ELPLM13	ELPLM14	ELPLL09	ELPLL10	ELPLR05	ELPLU05/ ELPLL09/ ELPLL10	ELPLW07/ ELPLM12/ ELPLM13/ ELPLM14
100	221 x 125	129 - 129	196 - 239	280 - 385	379 - 514	496 - 759	775 - 1154	1082 - 1616	1574 - 2346	-86 - -38	-139 - +14	-152 - +28
200	443 x 249	268 - 268	400 - 485	570 - 781	770 - 1040	1009 - 1534	1510 - 2267	2120 - 3188	3078 - 4623	-172 - -77	-277 - +28	-305 - +56
300	664 x 374	407 - 407	604 - 731	836 - 1145	1161 - 1565	1522 - 2309	2244 - 3381	3158 - 4761	4582 - 6900	-258 - -115	-416 - +42	-457 - +83
400	886 x 498	546 - 546	808 - 977	1150 - 1572	1552 - 2091	2035 - 3085	2978 - 4495	4196 - 6333	6085 - 9178	-344 - -154	-555 - +56	-609 - +111
500	1107 x 623	685 - 685	1012 - 1223	1440 - 1968	1944 - 2617	2548 - 3860	3713 - 5609	5234 - 7906	7589 - 11455	-430 - -192	-693 - +71	-762 - +139
600	1328 x 747	824 - 824	1216 - 1469	1730 - 2364	2335 - 3143	3061 - 4635	4447 - 6722	6271 - 9478	9093 - 13732	-516 - -231	-832 - +85	-914 - +167
700	1550 x 872	963 - 963	1420 - 1715	2020 - 2760	2726 - 3668	3574 - 5410	5181 - 7836	7309 - 11051	10596 - 16010	-602 - -269	-971 - +99	-1066 - +195
800	1771 x 996	1102 - 1102	1624 - 1961	2310 - 3155	3118 - 4194	4088 - 6185	5916 - 8950	8347 - 12623	12100 - 18287	-688 - -308	-1109 - +113	-1219 - +223
900	1992 x 1121	1241 - 1241	1828 - 2207	2600 - 3551	3509 - 4720	4601 - 6961	6650 - 10064	9385 - 14195	13604 - 20564	-774 - -346	-1248 - +127	-1371 - +250

<For screens with an aspect ratio of 4:3>

[Units: cm]

①	②	③								④		
Inches (Diagonally)	Width x Height	ELPLR05	ELPLU05	ELPLW07	ELPLM12	ELPLM13	ELPLM14	ELPLL09	ELPLL10	ELPLR05	ELPLU05/ ELPLL09/ ELPLL10	ELPLW07/ ELPLM12/ ELPLM13/ ELPLM14
100	203 x 152	143 - 143	217 - 264	309 - 425	418 - 567	548 - 838	850 - 1267	1187 - 1776	1727 - 2577	-102 - -50	-160 - +8	-175 - +23
200	406 x 305	296 - 296	442 - 535	629 - 861	849 - 1146	1009 - 1534	1659 - 2493	2330 - 3508	3383 - 5085	-205 - -100	-321 - +16	-351 - +46
300	610 x 457	449 - 449	666 - 806	860 - 1177	1280 - 1725	1678 - 2545	2467 - 3720	3474 - 5239	5039 - 7594	-307 - -150	-481 - +24	-526 - +69
400	813 x 610	602 - 602	891 - 1077	1150 - 1572	1711 - 2304	2243 - 3399	3276 - 4947	4617 - 6971	6696 - 10102	-410 - -200	-641 - +32	-702 - +92
500	1016 x 762	755 - 755	1116 - 1348	1440 - 1968	2142 - 2884	2809 - 4253	4085 - 6174	5760 - 8703	8352 - 12610	-512 - -250	-802 - +40	-877 - +115
600	1219 x 914	908 - 908	1340 - 1619	1730 - 2364	2573 - 3463	3374 - 5107	4894 - 7400	6903 - 10435	10008 - 15118	-614 - -300	-962 - +48	-1053 - +138
700	1422 x 1067	1062 - 1062	1565 - 1890	2020 - 2760	3004 - 4042	3939 - 5961	5703 - 8627	8046 - 12167	11664 - 17627	-717 - -350	-1122 - +56	-1228 - +161
800	1626 x 1219	1215 - 1215	1789 - 2161	2310 - 3155	3435 - 4621	4504 - 6814	6512 - 9854	9190 - 13899	13321 - 20135	-819 - -400	-1283 - +64	-1403 - +184

<ELPLX03>

[Units: cm]

①	②			③			④		
Inches (Diagonally)	16:10	16:9	4:3	16:10	16:9	4:3	16:10	16:9	4:3
120	259x162	266x149	244x183	89	91	101	-8 - 32	0 - 42	-9 - 37
200	431x269	443x249	406x305	151	155	171	-13 - 54	0 - 69	-15 - 61
300	646x404	664x374	610x457	228	235	259	-20 - 81	0 - 104	-23 - 91
400	862x538	886x498	813x610	306	315	347	-27 - 108	0 - 138	-30 - 122
500	1077x673	1107x623	1016x762	384	394	435	-34 - 135	0 - 173	-38 - 152
600	1292x808	1328x747	1219x914	461	474	523	-40 - 162	0 - 208	-46 - 183
700	1508x942	1550x872	1422x1067	539	554	610	-47 - 188	0 - 242	-53 - 213
800	1723x1077	1771x996	1626x1219	616	633	698	-54 - 215	0 - 277	-61 - 244
900	1939x1212	1992x1121	-	694	713	-	-61 - 242	0 - 311	-
1000	2154x1346	-	-	771	-	-	-67 - 269	-	-

■ Lens Compatibility Table

Lenses with the following model numbers are supported. Other lenses are not supported.

Lens Model Number	Projector Model Number	
	EB-L30002U EB-L30000U	EB-L25000U
ELPLX03	✓*1	✓*2
ELPLU05	✓	✓
ELPLW07	✓	✓
ELPLM12	✓	✓
ELPLM13	✓	✓
ELPLM14	✓	✓
ELPLL09	✓	✓
ELPLL10	✓	✓
ELPLR05	✓	✓

*1 To use this lens unit, you need to update the projector's firmware to version V1.05 or later.

*2 When you use this lens unit, contact Epson for help.

■ Available Lens Shift Adjustment Range

The ranges within which the image can be moved are shown below.

The position of the projected image cannot be moved to both the horizontal and vertical maximum values.

When using the ELPLX03

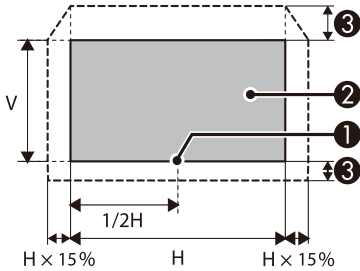

- ① Center of lens
- ② Projected image when the lens has moved to the home position
- ③ Maximum motion range*: Up $V \times 20\%$, Down $V \times 5\%$

* When the horizontal direction is set to the maximum, the image cannot be moved upward.

When using the ELPLR05

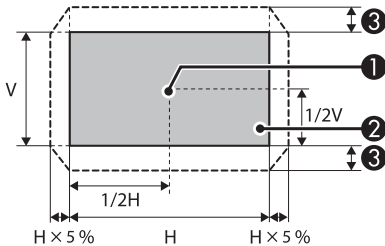

- ① Center of lens
- ② Projected image when the lens has moved to the home position
- ③ Maximum motion range*: $V \times 15\%$

* When the horizontal direction is set to the maximum, the image cannot be moved vertically.

When using the ELPLU05/ELPLL09/ELPLL10

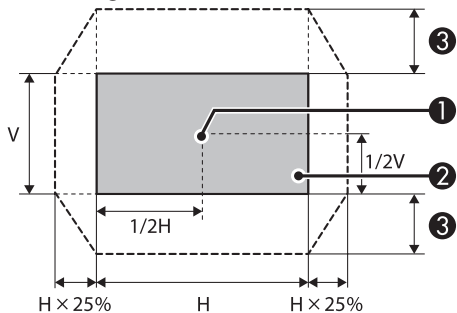

- ① Center of lens
- ② Projected image when the lens has moved to the home position
- ③ Maximum motion range: $V \times 55\%$ *

* When the horizontal direction is set to the maximum, the image cannot be moved vertically.

When using the ELPLW07/ELPLM12/ELPLM13/ELPLM14

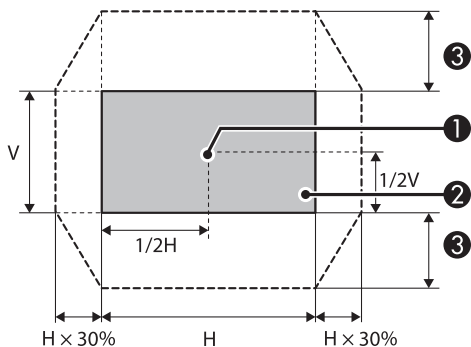

- ① Center of lens
- ② Projected image when the lens has moved to the home position
- ③ Maximum motion range: $V \times 65\%$ *

* $V \times 60\%$ when performing screen matching (ELPLM13)

* When the horizontal direction is set to the maximum, the image cannot be moved vertically.

Available Keystone Correction Range

H/V-Keystone

If the projector's angle of tilt is within the following range, you can correct distortion in the projected image by using the H/V-Keystone correction function.

Screen Position	ELPLX03	ELPLR05	ELPLU05	ELPLW07	ELPLM12	ELPLM13	ELPLM14	ELPLL09	ELPLL10
Vertical direction	-18° to 18°	-35° to 35°	-39° to 39°	-42° to 42°	-45° to 45°				
Horizontal direction	-30° to 30°								

Curved Surface

The values in the table are the minimum values for R/L in the illustration. (Approximate values when projecting at maximum zoom.)

Horizontally curved surface (concave)

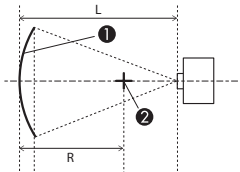

- ① Screen
 - ② Center of the circle of which the curved surface is an arc
- L Projection distance
R Radius of the circle of which the curved surface is an arc

Top view

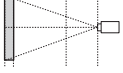
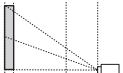
Lens Type	ELPLX03	ELPLR05	ELPLU05	ELPLW07	ELPLM12	ELPLM13	ELPLM14	ELPLL09	ELPLL10
Vertical lens shift: Home position  Side view	-	0.47	0.38	0.31	0.25	0.20	0.15	0.11	0.08
Vertical lens shift: Top  Side view	2.86	0.47	0.39	0.32	0.26	0.21	0.15	0.11	0.08

Horizontally curved surface (convex)

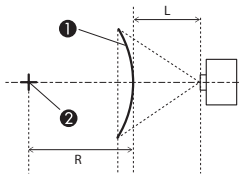

Top view

- ① Screen
- ② Center of the circle of which the curved surface is an arc
- L Projection distance
- R Radius of the circle of which the curved surface is an arc

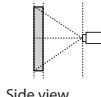
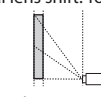
Lens Type	ELPLX03	ELPLR05	ELPLU05	ELPLW07	ELPLM12	ELPLM13	ELPLM14	ELPLL09	ELPLL10
Vertical lens shift: Home position  Side view	-	2.63	1.24	0.71	0.45	0.32	0.19	0.14	0.10
Vertical lens shift: Top  Side view	8.51	2.64	1.28	0.75	0.48	0.33	0.20	0.14	0.10

Vertically curved surface (concave)

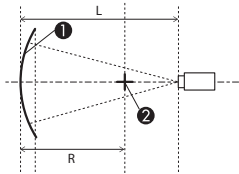

Side view

- ① Screen
- ② Center of the circle of which the curved surface is an arc
- L Projection distance
- R Radius of the circle of which the curved surface is an arc

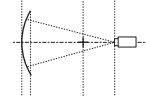
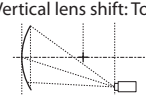
Lens Type	ELPLX03	ELPLR05	ELPLU05	ELPLW07	ELPLM12	ELPLM13	ELPLM14	ELPLL09	ELPLL10
Vertical lens shift: Home position  Side view	-	0.38	0.30	0.23	0.18	0.14	0.11	0.08	0.07
Vertical lens shift: Top  Side view	2.09	0.39	0.37	0.28	0.21	0.16	0.11	0.09	0.07

Vertically curved surface (convex)

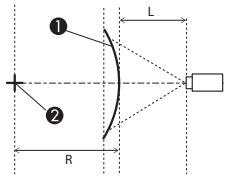

- ① Screen
- ② Center of the circle of which the curved surface is an arc
- L Projection distance
- R Radius of the circle of which the curved surface is an arc

Side view

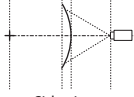
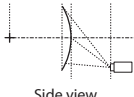
Lens Type	ELPLX03	ELPLR05	ELPLU05	ELPLW07	ELPLM12	ELPLM13	ELPLM14	ELPLL09	ELPLL10
Vertical lens shift: Home position  Side view	-	1.24	0.63	0.37	0.24	0.17	0.12	0.09	0.06
Vertical lens shift: Top  Side view	4.28	1.26	0.73	0.44	0.29	0.20	0.13	0.09	0.07

Corner Wall

The α in the illustration is the maximum angle in which the projector can move. See the table below for detailed values. (Approximate values when projecting at maximum zoom.)

Concave horizontal corner correction (correction to bilateral symmetry by using corners as the center line)

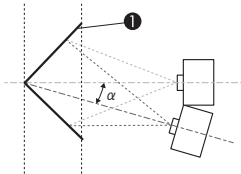

Top view

① Screen

α Movable angle of the projector

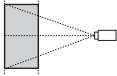
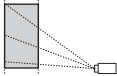
Lens Type	ELPLX03	ELPLR05	ELPLU05	ELPLW07	ELPLM12	ELPLM13	ELPLM14	ELPLL09	ELPLL10
Vertical lens shift: Home position  Side view	-	28°	32°	32°	31°	31°	30°	29°	28°
Vertical lens shift: Top  Side view	-	24°	19°	22°	26°	30°	29°	29°	28°

Convex horizontal corner correction (correction to bilateral symmetry by using corners as the center line)

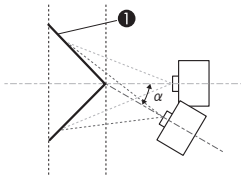

Top view

① Screen

α Movable angle of the projector

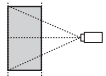
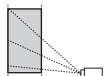
Lens Type	ELPLX03	ELPLR05	ELPLU05	ELPLW07	ELPLM12	ELPLM13	ELPLM14	ELPLL09	ELPLL10
Vertical lens shift: Home position  Side view	-	-	7°	13°	17°	19°	23°	24°	26°
Vertical lens shift: Top  Side view	-	-	6°	12°	16°	19°	23°	24°	26°

Concave vertical corner correction (correction to horizontal symmetry by using corners as the center line)

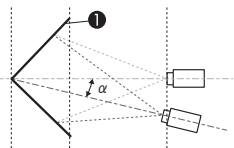

① Screen
 α Movable angle of the projector

Side view

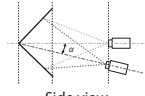
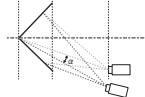
Lens Type	ELPLX03	ELPLR05	ELPLU05	ELPLW07	ELPLM12	ELPLM13	ELPLM14	ELPLL09	ELPLL10
Vertical lens shift: Home Position  Side view	-	33°	32°	31°	28°	26°	24°	23°	23°
Vertical lens shift: Top  Side view	-	24°	11°	13°	14°	15°	18°	20°	21°

Convex vertical corner correction (correction to horizontal symmetry by using corners as the center line)

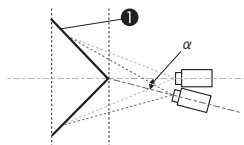

① Screen
 α Movable angle of the projector

Side view

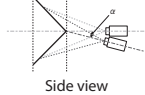
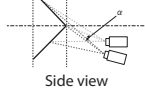
Lens Type	ELPLX03	ELPLR05	ELPLU05	ELPLW07	ELPLM12	ELPLM13	ELPLM14	ELPLL09	ELPLL10
Vertical lens shift: Home position  Side view	-	8°	15°	18°	21°	22°	22°	22°	22°
Vertical lens shift: Top  Side view	-	2°	-	3°	9°	13°	16°	19°	20°

■ Curved Surface Correction Range for Camera Assist

You can correct the image shape if the curved surface is a part of an exact circle. The values in the table are the minimum values for R/L shown in the illustration. They are determined in the following conditions:

- Projecting at maximum zoom
- R is 280 cm or more
- Projecting a 150 inch image per one projector

You may not be able to correct the image shape if the value is lower than the R/L value in the table.

You can confirm the maximum projection distance (L) using the following formula.

$L = R/\text{value in the table}$

Horizontally curved surface (concave)

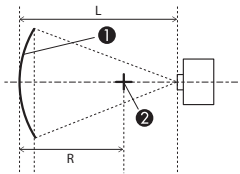

- ① Screen
 - ② Center of the circle of which the curved surface is an arc
- L Projection distance
R Radius of the circle of which the curved surface is an arc

Top view

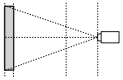
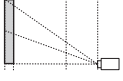
Lens Type	ELPLX03	ELPLU05	ELPLW07	ELPLM12	ELPLM13	ELPLM14
Vertical lens shift: Home position  Side view	-	0.96	0.67	0.50	0.38	0.25
Vertical lens shift: Top  Side view	2.86	0.96	0.67	0.50	0.38	0.25

Horizontally curved surface (convex)

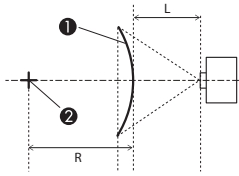

Top view

- ① Screen
- ② Center of the circle of which the curved surface is an arc
- L Projection distance
- R Radius of the circle of which the curved surface is an arc

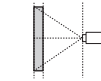
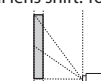
Lens Type	ELPLX03	ELPLU05	ELPLW07	ELPLM12	ELPLM13	ELPLM14
Vertical lens shift: Home position  Side view	-	1.24	0.71	0.50	0.38	0.25
Vertical lens shift: Top  Side view	8.51	1.28	0.75	0.50	0.38	0.25

Vertically curved surface (concave)

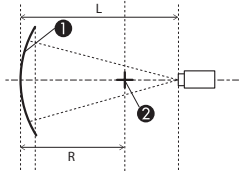

Side view

- ① Screen
- ② Center of the circle of which the curved surface is an arc
- L Projection distance
- R Radius of the circle of which the curved surface is an arc

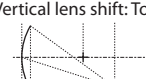
Lens Type	ELPLX03	ELPLU05	ELPLW07	ELPLM12	ELPLM13	ELPLM14
Vertical lens shift: Home position  Side view	-	0.96	0.67	0.50	0.38	0.25
Vertical lens shift: Top  Side view	2.48	0.96	0.67	0.50	0.38	0.25

Vertically curved surface (convex)

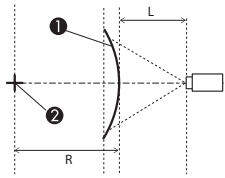

- ① Screen
- ② Center of the circle of which the curved surface is an arc
- L Projection distance
- R Radius of the circle of which the curved surface is an arc

Side view

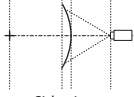
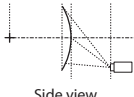
Lens Type	ELPLX03	ELPLU05	ELPLW07	ELPLM12	ELPLM13	ELPLM14
Vertical lens shift: Home position  Side view	-	0.96	0.67	0.50	0.38	0.25
Vertical lens shift: Top  Side view	4.28	0.96	0.67	0.50	0.38	0.25

■ Installation Angle

You can install the projector in any position in a 360° radius. There are no restrictions on the installation angle in either the horizontal or vertical direction.

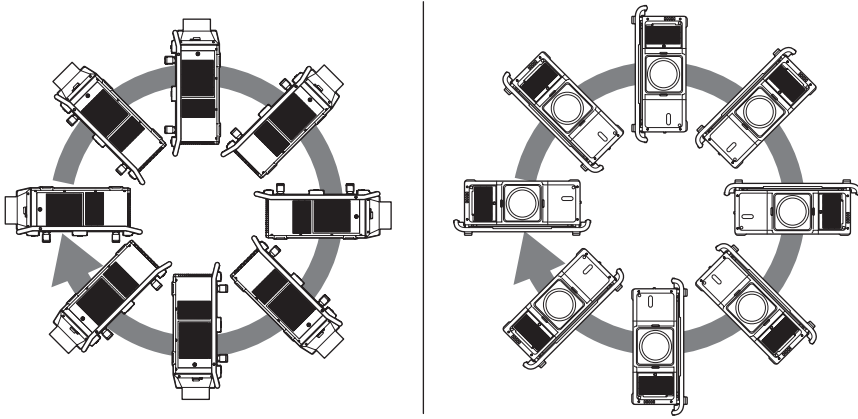

■ Installation Range

Note the following points when installing so that the projector's air intake vent or air exhaust vent are not covered.

- Make sure you secure the following space around the projector.

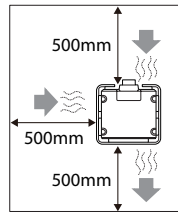

- When setting up multiple projectors, make sure there is a gap of at least 200 mm between the projectors.

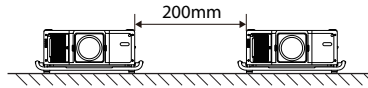

- Make sure you secure the following space when installing with the air intake vent underneath. A gap of at least 100 mm between the installation surface and the air intake vent. A space of 800 x 350 mm around the entrance of the air intake vent.

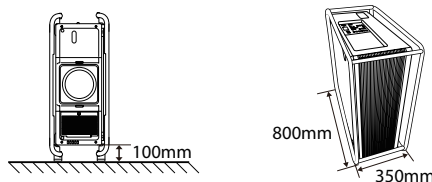

Serial Connection

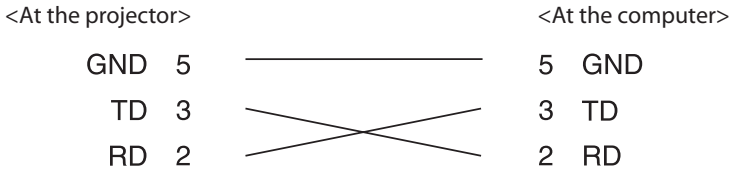
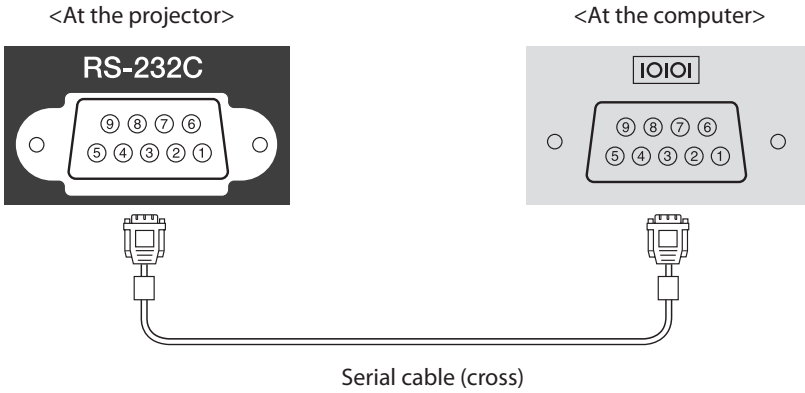

<Serial port specifications>

- Connector shape: D-Sub 9-pin (male)
- Projector input port name: RS-232C

<Communication specifications>

- Default baud rate setting: 9600 bps
- Data length: 8 bit
- Parity: None
- Stop-bit: 1 bit
- Flow control: None

■ Monitoring and Control

The projector can be monitored and controlled using the following methods. For more details, see the "User's Guide" supplied with the projector.

● ESC/VP21 commands

- When the projector is connected to a computer with an RS-232C cable, you can control the projector with communication commands.
- You can control the projector from a computer connected to the optional HDBaseT transmitter with an RS-232C cable.

● Epson Web Control

By using the Web browser of a computer or a mobile device connected to the projector on a network, you can make projector settings or control the projector.

● PLink commands

The projector complies with the PLink Class2 standard established by the JBMIA. From a computer connected to the projector on a network, you can control the projector with PLink commands.

For more details on PLink, see the following Web site.
<http://pjlink.jbmia.or.jp/english/>

● Art-Net commands

Art-Net uses an Ethernet communication protocol based on the TCP/IP protocols. You can control the projector using a DMX controller or application system.

● Epson Projector Management (Software provided by Epson)

Allows you to control multiple Epson projectors on a network. Download the Epson Projector Management software from the following website.
<http://www.epson.com/>

ESC/VP21 Command List

When the power on command is transmitted to the projector, the power turns on and it enters warm-up mode. When the projector's power has turned on, a colon ":" (3Ah) is returned.

When a command is input, the projector executes the command and returns a ":", and then accepts the next command.

If the command being processed terminates abnormally, an error message is output and a ":" is returned.

Power on/off

Function	Command	Response Value	Content
Power on	PWR ON		
Power off	PWR OFF		
Power status query	PWR?	00	Standby condition
		01	Projecting
		02	Warm-up status
		03	Cooling status
		04	Network monitoring status/communication status
		05	Error standby status
		09	Standby status (external output of images is possible)

Switch input source

Function	Command	Setting Value/ Response Value	Content
Switch input source	SOURCE	10	Computer
Acquire input source	SOURCE?	11	Computer
		14	Computer
		1F	Computer
		30	HDMI
		53	LAN
		60	SDI
		80	HDBaseT
		A0	DVI-D
		B0	BNC
		B1	BNC
		B4	BNC
		BF	BNC
		F0	Switch to all input sources in order
		F1	Switch to DVI-D, Computer, BNC, and LAN in order
		F2	Switch to HDMI, HDBaseT, and SDI in order

Shutter Function

Function	Command	Setting Value	Content
Shutter Function	MUTE	ON	On
	MUTE?	OFF	Off

On-Screen Display settings

Function	Command	Setting Value	Content
On-Screen Display	ONSCREEN	00	Do not display menus and messages
	ONSCREEN?	01	Display menus and messages

Configuration menu

INC: Increase the setting value/DEC: Decrease the setting value/INIT: Return to defaults

Top Menu	Sub-menu	Epson Web Control Setting Availability	ESC/VP21 Public Commands		
			Command	Setting Value/Response Value	
Image	Color Mode	✓	CMODE xx CMODE?	04: Presentation 06: Dynamic 07: Natural 0E: BT.709 0F: DICOM SIM 15: Cinema 1A: Multi-Projection INIT (settings only)	
	Brightness	✓	BRIGHT xxx BRIGHT?	0-255 INIT/INC/DEC (settings only)	
	Contrast	✓	CONTRAST xxx CONTRAST?	0-255 INIT/INC/DEC (settings only)	
	Color Saturation	✓	DENSITY xxx DENSITY?	0-255 INIT/INC/DEC (settings only)	
	Tint	✓	TINT xxx TINT?	0-255 INIT/INC/DEC (settings only)	
	Sharpness	✓	SHARP x1 x2 SHARP? x2	x1: Adjustment value 0-255 INC/DEC/INIT x2: Specify specific range 00: Standard (optional) 01: Thin Line Enhancement 02: Thick Line Enhancement	
	White Balance	Color Temp.	✓	CTEMP xxx CTEMP?	0-255 INIT/INC/DEC (settings only)
		G-M Correction	✓	FCOLOR xxx FCOLOR?	0-255 INIT/INC/DEC (settings only)
		Offset R Offset G Offset B	✓	OFFSETR xxx OFFSETR? OFFSETG xxx OFFSETG? OFFSETB xxx OFFSETB?	0-255 INIT/INC/DEC (settings only)
		Gain R Gain G Gain B	✓	GAINR xxx GAINR? GAING xxx GAING? GAINB xxx GAINB?	0-255 INIT/INC/DEC (settings only)
	Image Enhancement	4K Enhancement	✓	4KENHANCE xx 4KENHANCE?	00: Off 01: Full HD 02: WUXGA+
		Image Preset Mode	✓	IMGPRESET xx IMGPRESET?	00: Off 01: Preset 1 02: Preset 2 03: Preset 3 04: Preset 4 05: Preset 5 INIT (settings only)
		Frame Interpolation	✓	MCFI xx MCFI?	00: Off 01: Low 02: Normal 03: High INIT (settings only)
		Deinterlacing	✓		-
Noise Reduction		✓	NRS xxx NRS?	0-255 INIT/INC/DEC	

Top Menu	Sub-menu		Epson Web Control Setting Availability	ESC/VP21 Public Commands	
				Command	Setting Value/Response Value
		MPEG Noise Reduction	✓	MPEGNRS xx MPEGNRS?	00: Off 01: Low 02: Normal 03: High
		Super-resolution	✓	SHRF xxx SHRF? SHRS xxx SHRS?	0-255 INIT/INC/DEC (settings only)
		Detail Enhancement	✓	DERANGE xxx DERANGE? DESTRENGTH xxx DESTRENGTH?	0-255 INIT/INC/DEC (settings only)
	Advanced	Gamma	✓	GAMMA xx GAMMA?	17: Setting 5/Gamma 1.7 18: Setting 4/Gamma 1.8 19: Setting 3/Gamma 1.9 20: Setting 2/Gamma 2.0 21: Setting 1/Gamma 2.1 22: Setting 0/Gamma 2.2 23: Setting -1/Gamma 2.3 24: Setting -2/Gamma 2.4 25: Setting -3/Gamma 2.5 26: Setting -4/Gamma 2.6 27: Setting -5/Gamma 2.7 F0: Custom INIT (settings only)
		Gamma (Custom)	-	GAMMALV x1 x2 GAMMALV? x1	x1: Gradient 00-08: Gradient 1 to Gradient 9 x2: Adjustment value 0-255 NC/DEC
		RGBCMY	✓		
		Light Source Control	✓		-
		Reset	✓		

Top Menu	Sub-menu		Epson Web Control Setting Availability	ESC/VP21 Public Commands	
				Command	Setting Value/Response Value
Signal	Resolution		✓		-
	Aspect		✓	ASPECT xx ASPECT?	00: Normal 10: 4:3 20: 16:9 30: Auto 40: Full 50: H-Zoom 60: Native A0: V-Zoom INIT (settings only) <Response value when "Auto" is selected> x1: Mode x2: Auto setting value (fixed at 30)
	Tracking		✓	TRACKING xxx TRACKING?	0-255 INIT/INC/DEC (settings only)
	Sync.		✓	SYNC xxx SYNC?	0-255 INIT/INC/DEC (settings only)
	Position		✓	HPOS xxx HPOS? VPOS xxx VPOS?	0-255 INIT/INC/DEC (settings only)
	Auto Setup		✓		-
	Overscan		✓	OVSCAN xx OVSCAN?	00: Off 02: 4% 04: 8% A0: Auto INIT (settings only)
	Blanking		✓		-
	Color Space		✓	CLRSPACE xx CLRSPACE?	00: Auto 01: BT.709 02: BT.2020
	Dynamic Range	Dynamic Range	✓	DYNRANGE xx DYNRANGE?	00: Auto 01: SDR 20: HDR10 30: HLG
		HDR10 Settings	✓	HDRPQ xx HDRPQ?	01-16: HDR10 Mode
		HLG Settings	✓	HDRHLG xx HDRHLG?	01-16: HLG Mode
	Advanced	Video Range	✓		
		Input Signal	✓		
		BNC Sync Termination	-		
		EDID	-		
		DDC Buffer	-		
Scale		✓			
Reset		✓			

Top Menu	Sub-menu		Epson Web Control Setting Availability	ESC/VP21 Public Commands	
				Command	Setting Value/Response Value
Settings	Geometry Correction		✓	CORRECTMET x1 CORRECTMET?	00: Off 01: H/V-Keystone 02: Quick Corner 03: Point Correction 04: Curved Surface 05: Corner Wall
		H/V-Keystone	✓	VKEYSTONE xxx VKEYSTONE? HKEYSTONE xxx HKEYSTONE? VBALANCE xxx VBALANCE? HBALANCE xxx HBALANCE?	0-255 INIT/INC/DEC (settings only)
		Quick Corner	✓	QC x1 x2 x3 x4 x5 x6 x7 x8 (Set coordinates)	x1-8: 4999- 000 Specify in the order: top left (x, y), top right (x, y), bottom right (x, y), bottom left (x, y)
				QC? (Acquire coordinate settings)	-4999-5000 Coordinates (x, y) for 4 points are divided into 4 lines and responded
				QCV x1 x2 x3 x4 x5 x6 x7 x8 (Vector settings)	x1-x8: 0-99 Specify in the order: top left (x, y), top right (x, y), bottom right (x, y), bottom left (x, y)
		Curved Surface	✓		
	Corner Wall	✓			
	Point Correction	✓			
	Split Screen		✓	SPS x1 x2 SPS?	x1 01: Execute/Release Split Screen x2 00: Release Split Screen 01: Execute Split Screen
					x1 02: Set Screen Size x2 00: Equal 01: Larger Left 02: Larger Right
					x1 03: Source (Screen Left) 04: Source (Screen Right) x2 See "Switch input source".
					x1 05: Swap Screens
					x2 00: Auto 01: Screen Left 02: Screen Right
x1 00: Acquire All Current Settings (information only)					
x1 INIT					
Lock Setting	Control Panel Lock	✓			
	Lens Lock	✓			

Top Menu	Sub-menu		Epson Web Control Setting Availability	ESC/VP21 Public Commands	
				Command	Setting Value/Response Value
	Brightness Settings	Light Source Mode	✓	LUMINANCE xx LUMINANCE?	00: Normal 01: Quiet 04: Extended 05: Custom INIT (settings only)
		Brightness Level	✓	LUMLEVEL level xxx LUMLEVEL?	0-255 INIT/INC/DEC (settings only)
		Constant Brightness	✓	LUMCONST xx LUMCONST?	00: Off 01: On
		Estimated Remains	✓		-
	Remote Receiver		✓		
	User Button		-		-
	Test Pattern		✓		
	Memory	Memory	✓	POPMEM x1 x2 (Load) PUSHMEM x1 x2 (Register) ERASEMEM x1 x2 (Delete) - (Rename)	x1 Memory Type 02: Advanced x2 Memory No. 01: Memory 1 (1st) 02: Memory 2 (2nd) 03: Memory 3 (3rd) 04: Memory 4 (4th) 05: Memory 5 (5th) 06: Memory 6 (6th) 07: Memory 7 (7th) 08: Memory 8 (8th) 09: Memory 9 (9th) 0A: Memory 10 (10th)
		Lens Position	✓	POPLP xx (Load) PUSHLP xx (Register) ERASELP xx (Delete)	00: All 01: Memory 1 (1st) 02: Memory 2 (2nd) 03: Memory 3 (3rd) 04: Memory 4 (4th) 05: Memory 5 (5th) 06: Memory 6 (6th) 07: Memory 7 (7th) 08: Memory 8 (8th) 09: Memory 9 (9th) 0A: Memory 10 (10th)
		Geometry Correction	✓	POPGC x1 (Load) PUSHGC x1 (Register) ERASEGC x1 (Delete) NAMEGC x1 x2 (Rename) NAMEGC? x1 (Acquire Name)	x1 Memory Type 00: ALL 01: Memory 1 (1st) 02: Memory 2 (2nd) 03: Memory 3 (3rd) x2 Custom name (ASCII code)
Reset		✓		-	

Top Menu	Sub-menu		Epson Web Control Setting Availability	ESC/VP21 Public Commands	
				Command	Setting Value/Response Value
Extended	Display	Menu Position	✓	MENUDISP x1 x2 MENUDISP? x1	x1: Specify Setting Mode 01: Menu Position x2: Menu Position 00: Center 01: Center Left 02: Top Left 03: Top Center 04: Top Right 05: Center Right 06: Bottom Right 07: Bottom Center 08: Bottom Left INIT (settings only)
		Message Position	-	MSGPOS xx MSGPOS?	00: Center 01: Center Left 02: Top Left 03: Top Center 04: Top Right 05: Center Right 06: Bottom Right 07: Bottom Center 08: Bottom Left
		Messages	✓		
		Display Background	✓		
		Startup Screen	✓		
		Standby Confirmation	✓	STANDBYCONF xx STANDBYCONF?	00: Standby Confirmation Off 01: Standby Confirmation On INIT (settings only)
		Air Filter Notice	✓	FLCLENOT xx FLCLENOT?	00: Off 01: On INIT (settings only)
		Screen	✓	SCFORMAT x1 x2 SCFORMAT? x1	x1: Screen Type Settings 01: 4:3 02: 16:9 03: 16:10 x2: Screen Position Settings C19 (-999) to 000 to 3E7 (999) INIT (settings only)
		Panel Alignment	✓		
		Color Uniformity	✓		
	OSD Rotation	✓	OSDROTATE xx OSDROTATE?	00: Off 01: Rotate Right 90 Degrees 02: Rotate Left 90 Degrees	
	User's Logo		-		
	Projection		✓	VREVERSE xx VREVERSE? HREVERSE xx HREVERSE?	ON: Reversed OFF: Normal INIT (settings only)

Top Menu	Sub-menu		Epson Web Control Setting Availability	ESC/VP21 Public Commands	
				Command	Setting Value/Response Value
Operation	Direct Power On	✓			
		✓			
		✓			
		✓			
	Startup Source Search	✓	STSEARCH xx	00: Off	
			STSEARCH?	01: On	
	Shutter Settings	✓	FADEIN xxx	0-9: 0.0s	
			FADEIN?	10-19: 0.5s	
			FADEOUT xxx	20-29: 1.0s	
			FADEOUT?	30-39: 1.5s	
			- (Shutter Timer)	40-49: 2.0s	
			- (Shutter Release)	50-59: 2.5s	
			- (Startup)	60-69: 3.0s	
			- (Standby)	70-79: 3.5s	
				80-89: 4.0s	
				90-99: 4.5s	
				100-109: 5.0s	
				110-119: 5.5s	
				120-129: 6.0s	
			130-139: 6.5s		
		140-149: 7.0s			
		150-159: 7.5s			
		160-169: 8.0s			
		170-179: 8.5s			
		180-189: 9.0s			
		190-199: 9.5s			
		200-209: 10.0s			
		210-255: No operations			
Beep	✓		-		
Indicators	✓	ILLUM xx	00: Off		
		ILLUM?	01: On		
Log Save Destination	✓	LOGTO xx	00: Built-in Memory		
		LOGTO?	01: USB and Internal Memory		
Batch Setup Range	✓	BARANGE xx	00: All		
		BARANGE?	01: Limited		
AC Voltage Monitoring	✓	ACMONITOR xx	00: Off		
		ACMONITOR?	01: On		
Date & Time	✓		-		
Lens Calibration	-	LENSCALB			
History	✓	LENSCALBHIST?	00: History Off		
			01: History On		
A/V Settings	A/V Output	✓	AVOUT xx	00: While Projecting	
			AVOUT?	01: Always On INIT (settings only)	
	Monitor Out	✓		-	
Standby Mode		✓		-	
HDBaseT	Control Communications	✓	HDBASET xx	00: Off	
			HDBASET?	01: On INIT (settings only)	
	Extron XTP	✓	XTP xx	00: Off	
			XTP?	01: On	

Top Menu	Sub-menu		Epson Web Control Setting Availability	ESC/VP21 Public Commands	
				Command	Setting Value/Response Value
	SDI Settings	Link Type	✓	SDILINK x1 x2 SDILINK? x1	x1 = Settings 00: SDI x2 = Link Type 00: Single (Auto) 01: Single (Manual)
		Manual Settings	✓	SDISET x1 x2 x3 x4 x5 x6 SDISET? x1	x1 = Source Settings 00: SDI x2 = SDI Type 00: SD 01: HD 02: 3G-A x3 = Resolution 00: 720x480 01: 720x576 02: 1280x720 03: 1920x1080 x4 = Refresh Rate 00: 23.98p 01: 24p 02: 25p 03: 29.97p 04: 30p 05: 50i 06: 50p 07: 59.94i 08: 59.94p 09: 60i 0A: 60p x5 = Color Sampling 00: YCbCr4:2:2 02: RGB4:4:4 x6 = Color Depth 00: 10bit INIT (Only when set)

Top Menu	Sub-menu	Epson Web Control Setting Availability	ESC/VP21 Public Commands		
			Command	Setting Value/Response Value	
	Color Calibration	✓		-	
	Multi-Projection	Projector ID	✓	PROJID xx PROJID?	00: Off 01 to 30: ID1 to ID30 INIT (settings only)
		Projector Grouping	✓		-
		Tiling	✓		-
		Geometry Correction	✓	See [Geometry Correction] from [Settings].	
		Edge Blending	✓		
		Black Level	✓		
		Scale	✓		
		Screen Matching	✓		-
		Color Mode	✓	See [Color Mode] from [Image].	
		Brightness Settings	✓	See [Brightness Settings] from [Settings].	
		Color Matching	✓	MULSCR x1 x2 x3	x1: Adjustment Type 01: Pattern Guide 05: Color Correct R 06: Color Correct G 07: Color Correct B 08: Color Correct (RGB Batch) x2: Level Settings 00: Off (x1 = 01 only) 01: Level 1 02: Level 2 03: Level 3 04: Level 4 05: Level 5 06: Level 6 07: Level 7 08: Level 8 FF: All x3: Adjustment value (except x1 = 01) 0-255 INIT/INC/DEC
			✓	MULSCR? x1	x1: Adjustment Type 01: Pattern Guide 05: Color Correct R 06: Color Correct G 07: Color Correct B Responds to the settings or level value for each level of the specified adjustment type. Level value: 00 to 08 Adjustment Number: 000 to 255
		Color Uniformity	✓		
	Black Level	✓			
	Reset	✓			
	Schedule Settings	✓			
	Language	-			
	Reset	✓			

Top Menu	Sub-menu		Epson Web Control Setting Availability	ESC/VP21 Public Commands	
				Command	Setting Value/Response Value
Info	Projector Info	Operation Hours	✓	ONTIME?	ONTIME=x1 x1: Operation Hours
		Source	✓	SOURCE?	See "Switch input source" for the response values.
		Input Signal	✓		-
		Resolution	✓	RESOL?	00: Auto 01-02, 08-1E, 20-2D: Manual A0: Customized 1 A1: Customized 2 F0: Wide F1: Normal INIT (settings only)
		Refresh Rate	✓		
		Sync Info	✓		
		Color Format	✓		
		Status	✓		
		Serial Number	✓		
		Lens Type	✓	SFLENS?	10: ELPLU05 11: ELPLW07 12: ELPLM12 13: ELPLM13 14: ELPLM14 15: ELPLL09 16: ELPLL10 17: ELPLR05 1E:ELPLX03 FF: Unknown
	Event ID	-			
	HDBaseT Signal Level	-			
	Light Source Info	Light Source Hours	✓	LAMP?	LAMP = x1 x1: Laser On Hours
		Estimated Remains	✓		-
	Version		✓		
	Status Information		✓		
	Voltage Warning Info		✓		
Temp Warning Info		✓			
Power On/Off History		✓			

Top Menu	Sub-menu		Epson Web Control Setting Availability	ESC/VP21 Public Commands	
				Command	Setting Value/Response Value
Reset	Reset All Memories		✓		-
	Refresh Mode	Hour(s)	✓	REFRESHTIME xx REFRESHTIME?	01: 1 hour 0D: 13 hours 02: 2 hours 0E: 14 hours 03: 3 hours 0F: 15 hours 04: 4 hours 10: 16 hours 05: 5 hours 11: 17 hours 06: 6 hours 12: 18 hours 07: 7 hours 13: 19 hours 08: 8 hours 14: 20 hours 09: 9 hours 15: 21 hours 0A: 10 hours 16: 22 hours 0B: 11 hours 17: 23 hours 0C: 12 hours 18: 24 hours
		Messages	✓	REFRESHMSG xx REFRESHMSG?	00: Messages Hidden 01: Messages
		Start	✓	REFRESH	-
	Light Source Calibration	Run Now	✓	LTCALB	-
		Run Periodically	✓	AUTOLTCALB xx AUTOLTCALB?	00: Off 01: On (Run Periodically)
		Schedule Settings	✓		-
		Last Run	✓	LASTLTCALB?	yyyyMMddHHmm (year/ month/day/hour/minute)
	Reset All Config		✓	INITALL	-
	Reset All (Factory Default)	Reset All (User Default)	✓	INITUSERDATA xx	xx: Enter the password
		Reset All (Factory Default)	✓	INITFACTORY xx	xx: Enter the password
		User Default Setting	✓	USERDATASET xx	xx: Enter the password
		Password	✓		-

Network menu

Top Menu	Sub-menu	Web Control Setting Availability	ESC/VP21 Public Commands	
			Command	Setting Value/Response Value
Basic	Projector Name	✓		
	PJLink Password	✓		
	Remote Password	✓		
	Web Control Password	✓		
	Monitor Password*1	✓		
	Moderator Password	✓		
	Projector Keyword	✓		
	Display Keyword	✓		
Display LAN Info.	✓			
Wireless LAN	Connection Mode	✓		
	Search Access Point	-		
	SSID	✓		
	Security	✓		
	Passphrase	✓		
	EAP Settings	✓		
	Channel	✓		
	IP Settings	✓		
	SSID Display	✓		
	IP Address Display	✓		
IPv6 Settings*2	✓			
Wired LAN	IP Settings	✓		
	IP Address Display	✓		
	IPv6 Settings*2	✓		
Notifications	Mail Notification	✓		
	SMTP Server	✓		
	Port Number	✓		
	From	✓		
	Address Setting	✓		
	SNMP	✓		
	Trap IP Address	✓		
	Community Name	✓		
	PJLink Notification	✓		
Notified IP Address	✓			
Others	Secure HTTP	✓		
	Web Server Certificate	✓		
	Priority Gateway	✓		
	AMX Device Discovery	✓		
	Crestron Connected	-		
	Art-Net	✓		
Message Broadcasting	✓			

*1 Can be set only in Web Control.

*2 Manual settings are only available in Web Control

PJLink Command List

See the following for more information on controlling the projector from a computer using PJLink protocols.

Function	Command	Setting Value/Response Value		Content	Notes
Power control instruction	POWR	0		Power off (standby/error standby)	
		1		Power-on (Light source on)	
Power status query	POWR?	0		Power off (standby/error standby)	
		1		Power-on (Light source on)	
		2		Cooling status	
		3		Warm-up status	
Input switch instruction Input switch query	INPT INPT?	11		Computer	
		13		BNC	
		31		DVI-D	
		32		HDMI	
		34		SDI	
		52		LAN	
		56		HDBaseT	
Input toggling list query	INST?	11		Computer	Displays a list of the available input sources of the projector.
		13		BNC	
		31		DVI-D	
		32		HDMI	
		34		SDI	
		52		LAN	
		56		HDBaseT	
Error status query	ERST?	First character	2	Fan error	"0" is displayed when no error has occurred.
		Second character	2	Laser error Laser on error	
		Third character	1	Temperature warning	
			2	Temperature error	
		Fourth character	0	Cover open (Does not apply to model being used.)	
		Fifth character	1	No air filter warning Filter warning	
			2	Filter error	
		Sixth character	1	Other warnings	
	2	Other errors			
Shutter Settings	AVMT	30		A/V mute off	Does not support video mute off/on (10/11) or audio mute off/on (20/21).
Shutter status query	AVMT?	31		A/V mute on	
Light source hours, lighting hour query	LAMP?	First number (1 to 5)	0 to 99999	Laser operation hours	
		Second number	0	Laser off	
			1	Laser on	
Projector name query	NAME?	*		*	* Displays the name set in [Network] - [Basic] - [Projector Name] from the projector's Configuration menu.
Manufacture name information query	INF1?	EPSON		Manufacture name	

Function	Command	Setting Value/Response Value	Content	Notes
Model name information query	INF2?	EPSON L30002U/L30000U	EB-L30002U/EB-L30000U	
Class information query	CLASS?	2	Class information	
Serial number query	SNUM?	11 figures	Projector's serial number	
Software version query	SVER?	(firmware version of projector in use)		
Input source name query	INNM?xx	(Input source)		xx stands for a 2-digit number used in the input toggling list query
Input signal resolution query	IRES?	(Horizontal resolution) x (Vertical resolution)		
Panel resolution query	RRES?	(Horizontal resolution) x (Vertical resolution)	Projector's native resolution	
Filter hour query	FILT?	(Air Filters Usage Time)		
Replacement filter query	RFIL?	ELPAF52	Air filter model number	
Freeze instruction Freeze status query	FREZ FREZ?	0	Restart video action	
		1	Stop video action	

- The password for PJLink is set in [Network] - [Basic] - [PJLink Password] from the projector's Configuration menu. If you do not want to use a password, leave [PJLink Password] blank.
- PJLink is a trademark applied for registration or is already registered in Japan, the United States of America and other countries and areas.

List of Art-Net Channel Specifications

Channel	Function	Operation		Parameter	Settings	Operation Content
1	Luminance (Dimming)	0% - 100%		0 - 255	0	Set the brightness of the image.
2	Shutter control	Shutter	Open	0 - 63	128	Enable/Disable Shutter.
		No operations		64 - 191		
		Shutter	Closed	192 - 255		
3	Display source	No operations		0 - 7	0	Display the set source.
		HDMI		8 - 15		
		No operations		16 - 23		
		HDBaseT		24 - 31		
		DVI-D		32 - 39		
		No operations		40 - 47		
		SDI		48 - 55		
		Computer		56 - 63		
		No operations		64 - 71		
		BNC		72 - 79		
		LAN		80 - 87		
		No operations		88 - 95		
		No operations		96 - 255		
4	Lens position	No operations		0 - 31	0	Move lens shift to the home position.
		Move to Home Position		32 - 63		
		No operations		64 - 255		
5	Horizontal lens shift	(+) Adjust Lens	Movement amount: Large	0 - 31	128	Performs Horizontal lens shift for the amount of movement specified.
			Movement amount: Medium	32 - 63		
			Movement amount: Small	64 - 95		
		No operations		96 - 159		
		(-) Adjust Lens	Movement amount: Small	160 - 191		
			Movement amount: Medium	192 - 223		
			Movement amount: Large	224 - 255		
6	Vertical lens shift	(+) Adjust Lens	Movement amount: Large	0 - 31	128	Performs Vertical lens shift for the amount of movement specified.
			Movement amount: Medium	32 - 63		
			Movement amount: Small	64 - 95		
		No operations		96 - 159		
		(-) Adjust Lens	Movement amount: Small	160 - 191		
			Movement amount: Medium	192 - 223		
			Movement amount: Large	224 - 255		

Channel	Function	Operation	Parameter	Settings	Operation Content	
7	Zoom	(+ Adjust Lens	Movement amount: Large	0 - 31	128	Performs Zoom for the amount of movement specified.
			Movement amount: Medium	32 - 63		
			Movement amount: Small	64 - 95		
		No operations	96 - 159			
		(-) Adjust Lens	Movement amount: Small	160 - 191		
			Movement amount: Medium	192 - 223		
			Movement amount: Large	224 - 255		
8	Focus	(+ Adjust Lens	Movement amount: Large	0 - 31	128	Performs Focus for the amount of movement specified.
			Movement amount: Medium	32 - 63		
			Movement amount: Small	64 - 95		
		No operations	96 - 159			
		(-) Adjust Lens	Movement amount: Small	160 - 191		
			Movement amount: Medium	192 - 223		
			Movement amount: Large	224 - 255		
9	Electronic distortion	(+ Adjust Lens	Movement amount: Large	0 - 31	128	Performs Electronic Distortion for the amount of movement specified.
			Movement amount: Medium	32 - 63		
			Movement amount: Small	64 - 95		
		No operations	96 - 159			
		(-) Adjust Lens	Movement amount: Small	160 - 191		
			Movement amount: Medium	192 - 223		
			Movement amount: Large	224 - 255		
10	Load Lens Memory	No operations	0 - 15	0	Loads the specified lens memory.	
		Load Lens Memory 1	16 - 31			
		Load Lens Memory 2	32 - 47			
		Load Lens Memory 3	48 - 63			
		Load Lens Memory 4	64 - 79			
		Load Lens Memory 5	80 - 95			
		Load Lens Memory 6	96 - 111			
		Load Lens Memory 7	112 - 127			
		Load Lens Memory 8	128 - 143			
		Load Lens Memory 9	144 - 159			
		Load Lens Memory 10	160 - 175			
No operations	176 - 255					

Channel	Function	Operation	Parameter	Settings	Operation Content
11	Power control instruction	Power off	0 - 63	128	Turns the power on/off.
		No operations	64 - 191		
		Power on	192 - 255		
12	Geometry correction	Off	0 - 15	255	Performs Geometry Correction.
		H/V-Keystone (Keystone)	16 - 31		
		Quick Corner	32 - 47		
		Point Correction	48 - 63		
		Curved Surface	64 - 79		
		Corner Wall	80 - 95		
		Loads geometry correction memory 1	96 - 111		Loads geometry correction memory.
		Loads geometry correction memory 2	112 - 127		
		Loads geometry correction memory 3	128 - 143		
13	Lock	Cannot operate	0 - 127	0	Enable/Disable Art-Net operations.
		Can operate	128 - 255		
14	Freeze	No operations	0 - 31	128	Enables/disables Freeze.
		Freeze Off	32 - 95		
		No operations	96 - 159		
		Freeze On	160 - 223		
		No operations	224 - 255		
15	Fade-in	0.0s	0 - 15	255	Fade-in time setting when the shutter is released
		0.5s	16 - 31		
		1.0s	32 - 47		
		1.5s	48 - 63		
		2.0s	64 - 79		
		2.5s	80 - 95		
		3.0s	96 - 111		
		3.5s	112 - 127		
		4.0s	128 - 143		
		5.0s	144 - 159		
		7.0s	160 - 175		
		10.0s	176 - 191		
		No operations	192 - 255		
16	Fade-out	0.0s	0 - 15	255	Fade-out time setting when the shutter is executed
		0.5s	16 - 31		
		1.0s	32 - 47		
		1.5s	48 - 63		
		2.0s	64 - 79		
		2.5s	80 - 95		
		3.0s	96 - 111		
		3.5s	112 - 127		
		4.0s	128 - 143		
		5.0s	144 - 159		
		7.0s	160 - 175		
		10.0s	176 - 191		
		No operations	192 - 255		

When controlling the projector using Art-Net and operating the projector using the remote control or control panel, the settings and projector status for the DMX controller or application system may differ. When you want to control all channels in the projector, set channel 13 to "Cannot operate", and then return it to "Can operate".

■ Image Maintenance

Reduced Burn-in (Refresh Mode)

When a still image or a video with little movement is projected for a long time, a residual image (burn-in) sometimes is left behind in the projected image. Burn-in is reduced by running the Refresh Mode.

The Refresh Mode can be started from [Refresh Mode] in the [Reset] menu of this projector. After this mode is executed, the power turns off when the preset time has elapsed.

If you have any concerns about burn-in even after running the Refresh Mode, contact your local dealer or the nearest address provided in the Epson Projector Contact List.

Adjusting the Color Balance of the Light Source (Light Source Calibration)

When performing Light Source Calibration, the difference between the white balance and the brightness level for the light source is corrected. We recommend running this function periodically.

Light Source Calibration can be run from [Light Source Calibration] in the [Reset] menu of this projector. The [Light Source Calibration] setting items are as follows. While Light Source Calibration is being run, projection is stopped temporarily.

- [Run Now]

Runs Light Source Calibration. Light Source Calibration cannot be run in the following cases.

- Within 20 minutes of turning on the projector.
- If the surrounding temperature gets too high, and the brightness of the projector's light source has been automatically dimmed.

- [Run Periodically]

When this is set to [On], Light Source Calibration is started automatically when the power is turned off every time the usage time reaches 100 hours. However, light source calibration does not start automatically in the following situations.

- Within 20 minutes of turning the power supply on
- When using the Shutter function
- Within 20 minutes of releasing the Shutter function
- When the projector is used continuously for 24 hours or more
- When using direct shutdown

Set to [Off] as required as Light Source Calibration also sometimes starts unintentionally during projection. To maintain projected images after adjustment by Multi-Projection, set Direct Shutdown to Off.

- [Schedule Settings]

Displays the Schedule Settings screen.

Light Source Calibration can be set to run periodically at a specified date and time.

When [Run Periodically] is set to [Off] or when using the projector continuously for 24 hours or more, performing Schedule Settings is recommended.

■ Cautions

1. The copyright for this guide is owned by the Seiko Epson Corporation. No part of this document may be reproduced, stored in a retrieval system, or transmitted in any form or by any means, electronic, mechanical, photocopying, recording, or otherwise, without the prior written permission of Seiko Epson Corporation.
2. This guide is only to be used as an instruction guide for projector products from the Seiko Epson Corporation.

■ Disclaimer

1. The contents of this document are subject to change without notice.
2. While every precaution has been taken in the preparation of this document, Seiko Epson Corporation assumes no responsibility for errors or omissions. Neither is any liability assumed for damages resulting from the use of the information contained herein.
3. Responsibility for use of this guide lies with the user. Seiko Epson Corporation shall not be liable to the purchaser of this product or third parties for damages, losses, costs, or expenses incurred by the purchaser or third parties as a result of use of this guide.

EPSON®